



Control components for VAV terminal units

TROX UNIVERSAL



TROX[®] TECHNIK

The art of handling air

TROX GmbH

Heinrich-Trox-Platz

47504 Neukirchen-Vluyn

Germany

Telephone: +49 (0) 2845 202-0

Fax: +49 (0) 2845 202-265

E-mail: trox@trox.de

Internet: www.trox.de

A00000067516, 1, GB/en

06/2019

© TROX GmbH 2017

1	General information	4	Strain relief.....	24
2	Safety and correct use	6	Cabling.....	24
	General safety notes.....	6	8	Commissioning
	Correct use.....	7	9	Maintenance
	Incorrect use.....	7		Safety.....
	Residual risks.....	7		Operation and maintenance.....
	Qualified staff.....	8		Zero point correction.....
3	Technical data	9		Replacing the fuse.....
4	Transport, storage and packaging	11	10	Decommissioning
	Delivery check.....	11		Removing the electronic controller.....
	Transport on site.....	11	11	Appendix
	Storage.....	11		30
	Packaging.....	11		
5	Product description	12		
	Volume flow control.....	12		
	Volume flow rate monitoring.....	12		
	Pressure monitoring.....	12		
	Shut-off monitoring.....	12		
	External signaling of setpoint deviation....	13		
	Interfaces and signal lamps on the controller casing.....	14		
	Interfaces and signal lamps in the controller casing.....	16		
6	Installation	18		
	Tube connection on the external pressure transducer.....	22		
7	Wiring	23		
	Safety instructions.....	23		
	Notes on wiring.....	23		
	Additional information on wiring.....	23		
	Limited voltage supply.....	23		
	Polarity of the power supply.....	24		
	Functional earth.....	24		

1 General information

About this manual

This installation and operating manual enables operating and service personnel to correctly install the TROX UNIVERSAL controller (hereinafter referred to as ‘controller’) and to use it safely and efficiently.

The electronic controller forms a functional unit with a variable air terminal unit (also called ‘control unit’).

Depending on the scope of order, the electronic controller can be equipped with optional expansion modules (EM-xx) at the factory (retrofitting possible).

This operating and installation manual is intended for use by fitting and installation companies, in-house technicians, technical staff, instructed persons, and qualified electricians or air conditioning technicians.

It is essential that these individuals read and fully understand this manual before starting any work. The basic prerequisite for safe working is to comply with the safety notes and all instructions in this manual.

The local regulations for health and safety at work and general safety regulations also apply.

This manual must be given to the system owner when handing over the system. The system owner must include the manual with the system documentation. The manual must be kept in a place that is accessible at all times.

Illustrations in this manual are mainly for information and may differ from the actual design. Discrepancies cannot be used to make any claims against the manufacturer.

In addition to this manual, the following documents apply

- Operating manual
 - EasyConnect configuration software
- Installation manual for VAV terminal unit(s)
- Installation manuals for EASYLAB components
 - Expansion module EM-AUTOZERO
 - Expansion module EM-V
 - Expansion module EM-TRF/EM-TRF-USV
 - Expansion module EM-LON
 - Expansion module EM-BAC-MOD
 - Expansion module EM-BAC-IP
 - Control panel BE-LCD
- General wiring documents
- Project-specific wiring documents

All documents can be downloaded from www.troxtechnik.com.

Project-specific information is provided together with the order confirmation or delivered together with the product.

TROX Technical Service

To ensure that your request is processed as quickly as possible, please keep the following information ready:

- Product name
- TROX order number
- Delivery date
- Brief description of the fault

Online	www.troxtechnik.com
Phone	+49 2845 202-400

Limitation of liability

The information in this manual has been compiled with reference to the applicable standards and guidelines, the state of the art, and our expertise and experience of many years.

The actual scope of delivery may differ from the information in this manual for bespoke constructions, additional order options or as a result of recent technical changes.

The obligations agreed in the order, the general terms and conditions, the manufacturer's terms of delivery, and the legal regulations in effect at the time the contract is signed shall apply.

Defects liability

For details regarding defects liability please refer to Section VI, Warranty Claims, of the Delivery and Payment Terms of TROX GmbH.

The Delivery and Payment Terms of TROX GmbH are available at www.troxtechnik.com.

Copyright

This document, including all illustrations, is protected by copyright and pertains only to the corresponding product.

Any use without our consent may be an infringement of copyright, and the violator will be held liable for any damage.

This applies in particular to:

- Publishing content
- Copying content
- Translating content
- Microcopying content
- Saving content to electronic systems and editing it

Safety notes

Symbols are used in this manual to alert readers to areas of potential hazard. Signal words express the degree of the hazard.

Comply with all safety instructions and proceed carefully to avoid accidents, injuries and damage to property.

DANGER!

Imminently hazardous situation which, if not avoided, will result in death or serious injury.

WARNING!

Potentially hazardous situation which, if not avoided, may result in death or serious injury.

CAUTION!

Potentially hazardous situation which, if not avoided, may result in minor or moderate injury.

NOTICE!





Potentially hazardous situation which, if not avoided, may result in property damage.

ENVIRONMENT!

Environmental pollution hazard.

Safety signs on the controller

The following symbols and signs are usually found in the work area. They apply to the very location where they are found.

	<p>Electric shock hazard!</p>
	<p>Disconnect the power supply before you open the device.</p> <p>Only skilled qualified electricians are allowed to work in areas marked as having electrical voltage.</p> <p>Unauthorised persons must not enter areas, open cabinets or work on components where an electrical voltage is present and which are hence marked with this symbol.</p>
	<p>General warning</p>
	<p>Read the operating and installation manual before commissioning and before you open the casing.</p>
	<p>Functional earth</p>

2 Safety and correct use

General safety notes



DANGER!

Risk of injury from the damper blade of the VAV terminal unit

The damper blades of VAV terminal units close or open extremely quickly ($\approx 90^\circ$ within 3 seconds) and may crush your hands and arms.

Connect ducts to both ends of a VAV terminal unit; if one end cannot be ducted, at least fit a perforated plate to prevent people from reaching into the terminal unit.



CAUTION!

Risk of injury from the casing cover falling shut

An open casing cover may suddenly fall shut and crush your fingers.

- Secure an open casing cover with a bracket.
- Wear protective gloves.



NOTICE!

Risk of damage to property due to large temperature differences

If any electronic components have been kept in an unheated area, condensation may form and damage the electronic components beyond repair.

- Before you start commissioning, make sure that all devices have warmed up to ambient temperature. Only after about 2 hours will the system have reached room temperature.



WARNING!

Danger due to illegible signage!

Over time, stickers and signs may fade or become otherwise illegible, meaning that hazards cannot be identified and necessary operating instructions cannot be followed. There is then a risk of injury.

- Ensure that all of the safety, warning and operating information is clearly legible.
- Replace illegible signs or stickers immediately.

! NOTICE!**Risk of damage to property due to electrostatic charge**

Electrostatic charge can damage the electronics.

- Avoid skin contact with any components or printed circuits.
- Touch an equipotentially bonded metal surface before you touch any printed circuit boards.
- Wear conductive footwear and antistatic clothing.

! NOTICE!**In an emergency**

Immediately disconnect the power supply to the controller. Emergencies include, for example, a damaged mains cable, a damaged casing, the ingress of a liquid or foreign matter, a smell or smoke.

Have the device checked by the manufacturer before you put it into operation again.

Correct use

Only use the device for its intended correct use and in compliance with the safety precautions and information in this manual in order to avoid danger to persons and property.

The correct use of this device encompasses:

- The electronic control of volume flow rate, room pressure or duct pressure for supply or extract air in conjunction with a TROX air terminal unit.
- Indoor use for ventilation and air conditioning systems.

- The controller is typically used in a group of several controllers for complete room control, but it may also be used as a single controller.
- For error-free operation, the installation orientation of the controller must be observed; possible installation orientations are indicated on the installation orientation label on the device.

Incorrect use

Do not use the controller in an installation orientation or for areas of application that are not described in this manual.

Do not use the controller outdoors, in wet areas, or in areas with potentially explosive atmospheres.

Residual risks**Power failure**

If the power fails, the damper blade of the VAV terminal unit remains in the position at that time; the controller will resume operation once power returns.

In control units with spring return actuator (TUNF), the control damper blade moves to a definable position (OPEN or CLOSED) in the event of a power failure.

For safety related applications you may use expansion module EM-TRF-USV, which ensures uninterrupted power supply. If the emergency power unit has been correctly connected and charged, it will supply power for the set operating times (☞ Technical Data for EM-TRF-USV).

Monitoring function

- Alarm signal in the event of insufficient volume flow rate, ☞ *on page 12*
- Alarm signal in the event of insufficient duct or room pressure, ☞ *on page 12*
- Alarm signal in the event of volume flow rate in shut-off position, ☞ *on page 12*



For safety related applications you should check whether then safety measures are required, such as alarms. You may use the alarm relay for switching operations.

Qualified staff

Skilled qualified electrician

Skilled qualified electricians are individuals who have sufficient professional or technical training, knowledge and actual experience to enable them to work on electrical systems, understand any potential hazards related to the work under consideration, and recognise and avoid any risks involved.

3 Technical data

Technical data									
Supply voltage	<p>24 V AC ±15% 50-60 Hz 24 V DC ±15%</p> <p> Do not use 24 V AC and 24 V DC power supplies at the same time!</p> <p>Optional: 230 V AC mains supply, only with the EM-TRF expansion module; optional: 230 V AC mains supply with UPS, only with the EM-TRF USV expansion module</p>								
Power rating	<p>The maximum power required depends on the construction of the controller. Typical constructions with different equipment result in the following values:</p> <table border="1" style="width: 100%; border-collapse: collapse;"> <tr> <td style="width: 80%;">Volume flow controller with standard actuator</td> <td style="text-align: right;">15 VA</td> </tr> <tr> <td>Volume flow controller with spring return actuator</td> <td style="text-align: right;">20 VA</td> </tr> <tr> <td>Volume flow controller with fast-running actuator</td> <td style="text-align: right;">29 VA</td> </tr> <tr> <td>Including all expansion modules</td> <td style="text-align: right;">40 VA max.</td> </tr> </table>	Volume flow controller with standard actuator	15 VA	Volume flow controller with spring return actuator	20 VA	Volume flow controller with fast-running actuator	29 VA	Including all expansion modules	40 VA max.
Volume flow controller with standard actuator	15 VA								
Volume flow controller with spring return actuator	20 VA								
Volume flow controller with fast-running actuator	29 VA								
Including all expansion modules	40 VA max.								
Connecting cable	<p>Double-stack terminal blocks for cables with a cross section up to 2.5 mm²</p> <p> The 24 V supply voltage may be connected for a maximum of 5 controllers.</p>								
Micro fuse	2.5 A, slow blow, 250 V, as glass fuse 5 x 20 mm								
Volume flow rate measurement	<p>Differential pressure transducer with room air induction to protect the measurement point</p> <p>Optional: Automatic zero point correction only with expansion module EM-AUTOZERO</p>								
Actuator	Fast-running high-precision actuator, $\pm 90^\circ$: 3 s								
Flow rate setting time	≤ 2 s, depending on duct pressure								
Controller recovery time after supply voltage failure	< 500 ms								
Plug and play communication system	<p>With automatic detection of the connected equipment and equipment functions:</p> <p>Communication cable: 300 m max.</p> <p>Number of controllers: max. 24 per segment</p>								
Temperature range	<p>Operation: 10 to +50 °C</p> <p>Storage: -10 to +70 °C</p>								
Humidity	<90% no condensation								
Area of application	Enclosed spaces								
Protection level	IP20								
IEC protection class	III (protective extra-low voltage)								

Dimensions

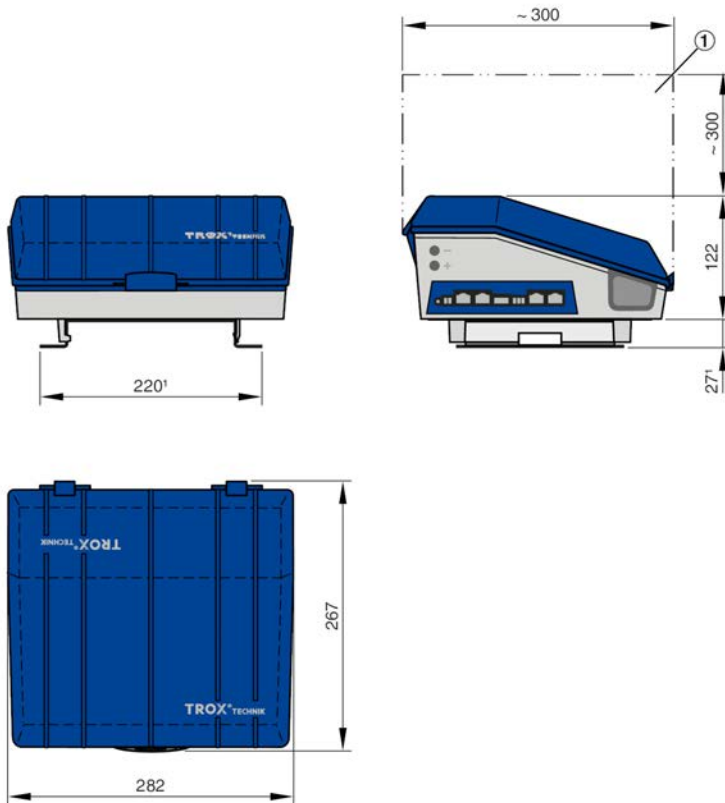

Fig. 1: Dimensions universal

① Keep clear to provide access

¹ In combination with TVRK, TVR, TVA, TVZ, TVJ, TVT, TA- / TZ-Silenzio, VMR, VME, VMRK

4 Transport, storage and packaging

Delivery check

Check delivered items immediately after arrival for transport damage and completeness. In case of any damage or an incomplete shipment, contact the shipping company and your supplier immediately.

A complete shipment includes:

- Electronic controller in a closed two-part casing, including:
 - Bracket for the cover
 - 2 cable glands, plastic (black)
 - 2 cable clips for strain relief (reusable)
 - Flow rate transducer (with tubes connected), for room or duct pressure controllers only with EM-C
 - 2-pin plug connector for connection X1
 - 3-pin plug connector for connection X5 (sensor AI)
- Expansion modules as ordered (see delivery note)
- Operating and installation manual



The electronic controller is typically delivered fully mounted on a TROX air terminal unit.

If any expansion modules have been ordered, the controller is factory fitted with these modules and shipped as a complete unit.

Transport on site

- If possible, take the controller in its transport packaging up to the installation location.
- Do not remove the protective wrapping until just before installation.

Storage

For temporary storage please note:

- Leave the device in its packaging and do not expose it to the effects of weather.
- Store the product in a dry place and away from direct sunlight
- Temperatur -10 ... +70 °C, humidity 90% max. (no condensation)

Packaging

Properly dispose of packaging material.

5 Product description

Volume flow control



Fig. 2: Example

- 1 VAV terminal unit, e.g. TVR
- 2 Damper blade
- 3 Actuator
- 4 Electronic controller TROX UNIVERSAL
- 5 Differential pressure sensor (internal)

The electronic controller is used in combination with an air terminal unit to control variable supply or extract air volumetric flow rates or for room or duct pressure control.

The controller includes a diaphragm pressure transducer that transforms the differential pressure (effective pressure) into an electric signal. The controller compares the actual value with the setpoint value and alters the control signal of the actuator if there is a difference between the two values.

Volume flow rate monitoring

The controller monitors the volume flow rate. If the actual value deviates by more than 4% (can be configured) from the setpoint value, a signal is emitted:

- The red LEDs (on opposite sides of the controller casing) blink continuously.
- The alarm relay of the controller drops out (wire break-proof).
- If necessary, external alarm signal ☞ *External signaling of setpoint deviation*

Pressure monitoring

The target pressure is monitored by the controller, if the actual value deviates from the configured pressure deviation, the following signal is emitted:

- The red LEDs (on opposite sides of the controller casing) blink continuously.
- The alarm relay of the controller drops out (wire break-proof).
- If necessary, external alarm signal ☞ *External signaling of setpoint deviation*

Shut-off monitoring

The controller monitors the damper blade position; if a volume flow is detected although the damper blade is in shut-off mode (override control), an alarm is emitted:

- The red LEDs (on opposite sides of the controller casing) blink continuously.
- The alarm relay of the controller drops out (wire break-proof).
- If necessary, external alarm signal ☞ *External signaling of setpoint deviation*

External signaling of setpoint deviation

The monitoring signals can be forwarded externally (only with optional equipment)

Monitoring of volume flow rate or room / duct pressure

- Display on the control panel BE-LCD:
 - Red light and sound (flow rate below setpoint)
 - Yellow light (flow rate above setpoint)
- Signaling to the higher-level system (only with expansion module EM-LON, EM-IP or EM-BAC-MOD)

Monitoring shut-off:

- Display on the control panel BE-LCD:
 - Yellow light (flow rate above setpoint)
- Signaling to the higher-level system (only with expansion module EM-LON, EM-IP or EM-BAC-MOD)

When installed, the controller is usually not accessible and the LEDs are not visible; for safety related applications, however, signals should be made visible (with an alarm relay, by others).

Interfaces and signal lamps on the controller casing

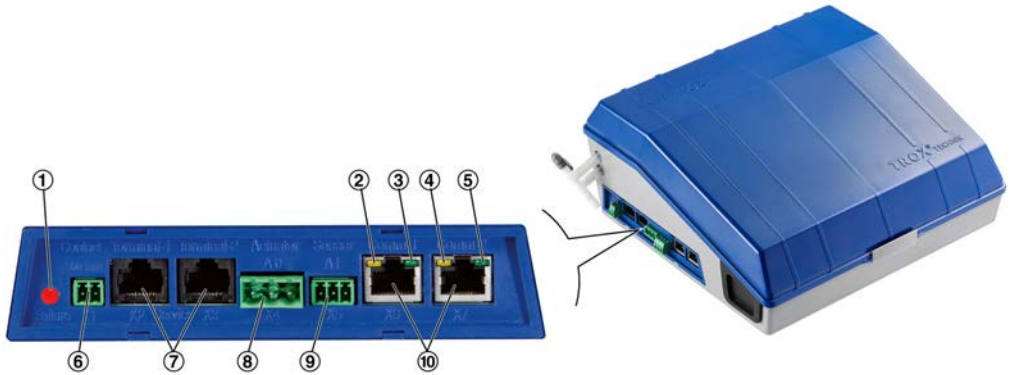

Fig. 3: Controller casing

Status LEDs

No.	Colour	Name	LED	Description
1	Red	Error	LED on	Up to 3 s: Switch-on procedure. Permanently: Switch-on procedure error
			LED blinking	Error; for detailed diagnosis use EasyConnect software
			LED blinking slowly	Undefined equipment function; for detailed diagnosis use EasyConnect software
			LED off	Normal operation; if no. 5 is also off ⇒ Equipment not ready for operation
2	Yellow	Cable termination	LED on	Cable termination is active
			LED off	Cable termination is inactive
3	Green	Not used		
4	Yellow	Data reception in progress	LED on	Data is being received from several controllers
			LED on with brief interruptions	Data is being received from few controllers
			LED off	No data reception from other devices
5	Green	Controller operation (heartbeat)	LED blinking slowly	Normal controller operation
			LED flickering	Controller operation; PC communication with EasyConnect configuration/diagnosis software
			LED off	Device not ready

External interfaces

No.	Name	Connection point for	Description
6	(X1)	Door contact	Connection for a volt-free door contact switch (only for room pressure control)
7	Terminal-1 (X2)	Control panel 1	Connection point for: <ul style="list-style-type: none"> ■ EASYLAB control panel BE-LCD ■ PC with EasyConnect software <ul style="list-style-type: none"> – BlueCon adapter – Special configuration cable ■ Tablet or smartphone with Android app EasyCon <ul style="list-style-type: none"> – BlueCon adapter
	Terminal-2 (X3)	Control panel 2	
8	Actuator (X4)	Actuator	The actuator of the damper blade is factory fitted.
9	Sensor (X5)	Analogue input AI5	For room or duct pressure control for connection of the pressure sensor, otherwise for connection of variable extract air/supply air volume flow rates can be used by 0-10 V DC signals. (Characteristic can be configured)
10	Comm-1 (X6)	Communication 1	RJ45 socket for SF-UTP network patch cables
	Comm-2 (X7)	Communication 2	
For details on the electrical data for each connection see ↗ <i>'List of terminal connections' on page 36</i>			

Interfaces and signal lamps in the controller casing

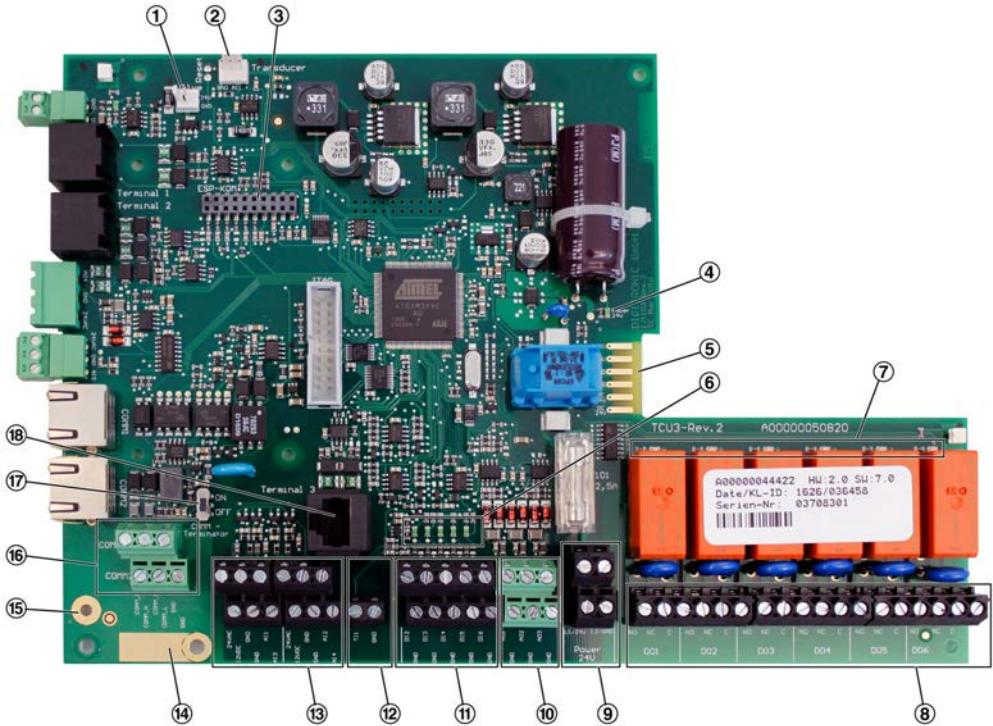

Fig. 4: Interfaces and signal lamps on the PCB

No.	Name	Description		
1	Valve connection	Connection point for expansion module EM-AUTOZERO		
2	Analogue input 1 (AI1)	Connection point for the integral diaphragm pressure transducer, analogue voltage 0-10 VDC, 10 mA max.		
3	Expansion slot 1 (ESP-KOM)	Connection for expansion modules to connect the controller to higher-level systems: <ul style="list-style-type: none"> ■ EM-LON: BUS communication LonWorks FT10 ■ EM-BAC-MOD: BUS communication BACNet MS/TP or MODBUS RTU ■ EM-IP: BUS communication BACnet IP or MODBUS IP as well as web server 		
4	Power 24 V	<table border="1" style="width: 100%; border-collapse: collapse;"> <tr> <td style="width: 50%;">LED on</td> <td style="width: 50%;">24 V supply voltage OK</td> </tr> </table>	LED on	24 V supply voltage OK
LED on	24 V supply voltage OK			

No.	Name	Description	
		LED off	24 V supply voltage failed / sagging
5	Connection of mains supply	Connection for EM-TRF and EM-TRF-USV expansion modules	
6	Status display for digital inputs DI1...DI6	LED on	Digital input DI is active
		LED off	Digital input DI is not active
7	Status display for digital outputs DO1...DO6	LED on	Digital output DO is active
		LED off	Digital output DO not active
8	Terminal block DO1...DO6	Digital outputs 1...6	Changeover relays
			max. 250 V AC 8 A, switch-on current 12 A max.
9	Terminal block, 24 V	Supply voltage 24 V AC or 24 V DC	
		⚠ Do not use 24 V AC and 24 V DC power supplies at the same time!	
10	Terminal block AO1... AO3	Analogue outputs 1...3	Can be configured for 0-10 V DC, 10 mA max.
11	Terminal block DI2...DI6	Digital inputs 2...6	For volt-free switch contacts 5 V DC xx mA
12	Terminal block TI1	Input for temperature sensor PT1000 (not supported)	
13	Terminal block AI1...AI4	Analogue inputs 1...4	Can be configured for 0-10 V DC, 10 mA max.
14	Clip / connection	Strain relief / connection for communication cable shield	
15	⏚ Functional earth	Connection point for the functional earth to improve electromagnetic compatibility (EMV)	
16	COMM-1 connection COMM-2 connection	Alternative terminals for the communication cable; in general, however, connection points Comm-1 (X6) and Comm-2 (X7) should be used (☞ on page 14/10).	
		SF-UTP network cable	
17	COMM terminal resistor	Switch ON	Communication cable termination is active
		Switch OFF	Communication cable termination is inactive
18	Terminal 3	Connection for TROX HPD actuator	
		⚠ Do not connect PD here	
For details on the electrical data for each connection see ☞ 'List of terminal connections' on page 36			

6 Installation

Installation orientation

The installation orientation of the controller is critical because of the diaphragm pressure transducer; approved installation orientations are shown on a sticker (Fig. 5) on the controller casing.

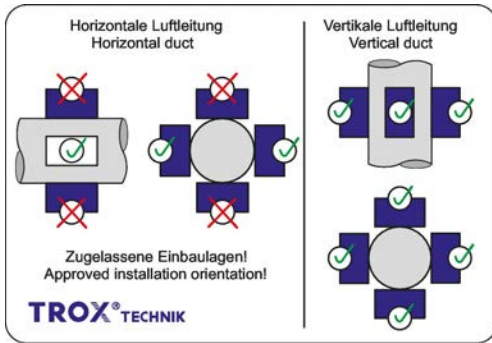

Fig. 5: Sticker showing the installation orientation

- Installation orientation OK
- Installation orientation not OK

Install the controller only as follows:

- On horizontal ducts (left side of the sticker)
 - Only on the side of a duct
Do not install the controller above or below a duct and neither anywhere in between.
- On vertical ducts (right side of the sticker)
 - Any installation orientation



Alternative installation orientation

The installation orientations shown on the sticker apply to the controller at the time of shipping. They depend on the position of the diaphragm pressure transducer in the controller casing. If you install the controller above or below a duct, you have to adapt the position of the diaphragm pressure transducer ↻ 18.

Alternative installation position of the diaphragm pressure transducer

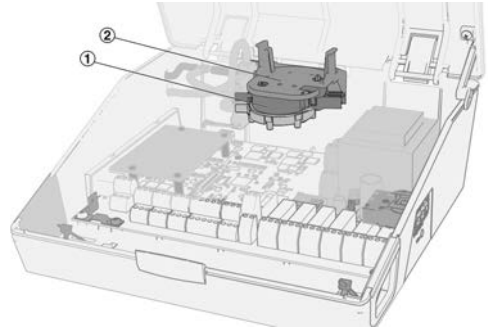
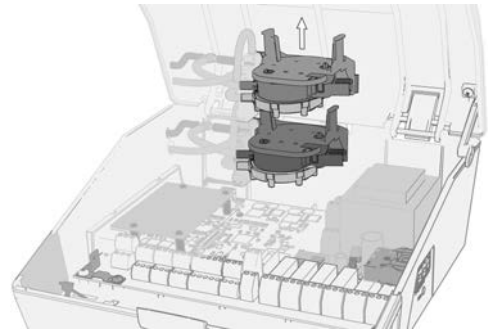

Fig. 6: Original position of the diaphragm pressure transducer at the time of shipping

The diaphragm pressure transducer (Fig. 6/1) and its holder (Fig. 6/2) are factory fitted in such a way that the installation orientations of the controller correspond to the sticker.

If necessary, you can adapt the controller for installation above or below a duct. To do so, you have to turn the diaphragm pressure transducer by 90°.



1. ▶ Grasp the diaphragm pressure transducer together with the holder and carefully lift it out of the casing. Be careful so as not to kink the pneumatic measuring tubes or to inadvertently disconnect any wires or cables.

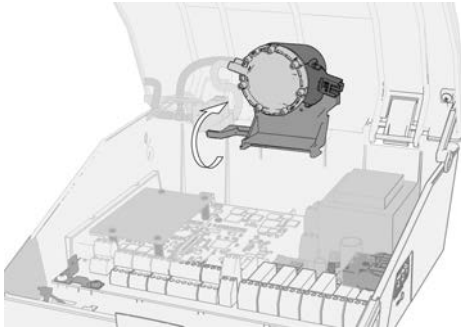

2. ▶ Turn the diaphragm pressure transducer by 90°.

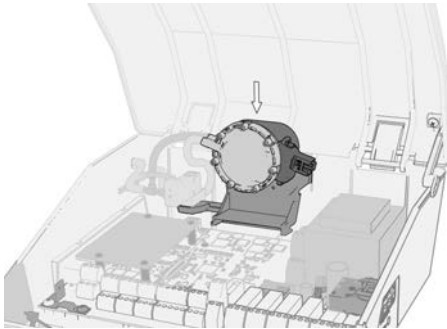

3. ▶ Insert the holder with the diaphragm pressure transducer again.



If the position of the diaphragm pressure transducer has been adapted, the controller must not be installed on the side of horizontal or vertical ducts.

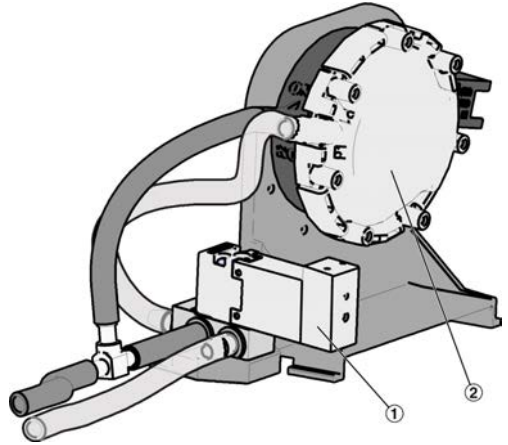

Fig. 7: Tubing

4. ▶ Check all connections and make sure that the tubes and wires of the transducer are properly connected and have not been kinked.

Connect any disconnected wires on the PCB:

Valve (1) - Connection to 'Valve' (Fig. 4/1)

Diaphragm pressure transducer (2) - Connection to 'Transducer' (Fig. 4/2)

Replace loosened tubing:

Blue tube - Connection to – (Minus)
transparent tube - Connection to + (Plus)

Wall installation

For restricted spaces you can detach the controller from the VAV terminal unit and install it on the wall next to the terminal unit or anywhere else nearby; to fix the controller on a wall, you can use a mounting bracket (Part no. E346GL3).

Do not extend the actuator cable or any measuring tubes.

Be sure to install the controller according to the sticker showing the correct installation orientations

↪ 18.

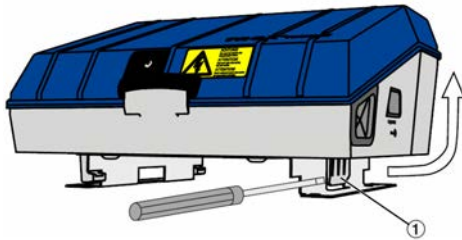
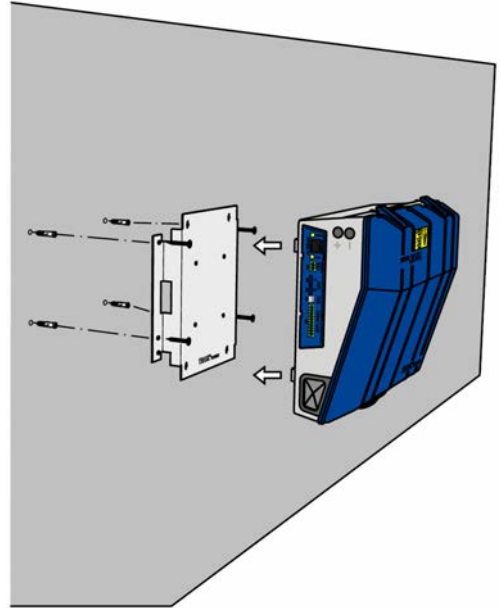

Fig. 8: Detaching the controller

1. ▶ Use a screwdriver to flip up the lug (1) and lift the controller.

In some cases, e.g. with TVLK, the controller is factory fitted to the terminal unit without a bracket.



2. ▶ Use suitable screws \varnothing 4 mm to fix the mounting bracket to the wall.

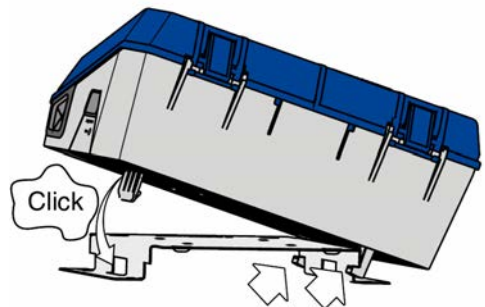

3. ▶ Press the controller casing as shown onto the mounting bracket until it clicks into place.

Tube connection on the external pressure transducer

Room pressure control – supply air

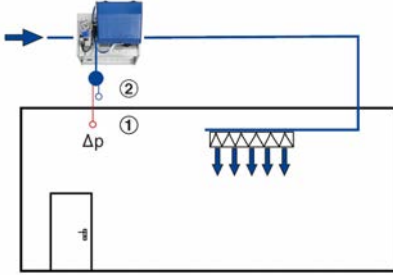

Measuring point	Tube connection PT699	
	Positive Room pressure	Negative Room pressure
1	+	-
2	-	+

Room pressure control – extract air

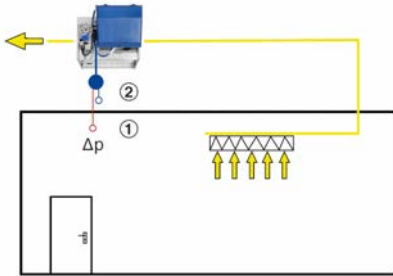

Measuring point	Tube connection PT699	
	Positive Room pressure	Negative Room pressure
1	+	-
2	-	+

Duct pressure control – supply air

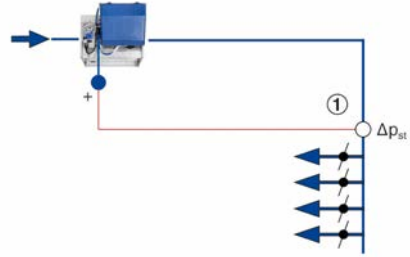

Measuring point	Tube connection PT699
1	+
	- (Atmosphere)

Duct pressure control – extract air

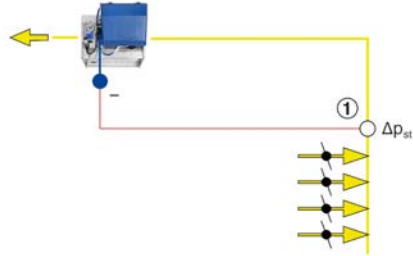

Measuring point	Tube connection PT699
1	-
	+ (Atmosphere)

7 Wiring

Safety instructions

Personnel:

- Skilled qualified electrician



DANGER!

Danger of death due to electric current!

Danger of electric shock! Do not touch any live components!

- Switch off the supply voltage and secure it against being switched on accidentally before working on the unit.
- Ensure that no voltage is present.
- Work on the electrical system must only be carried out by skilled qualified electricians.



CAUTION!

Risk of damage to the controller

For wiring please note:

- Do not connect the 24 V supply if the EM-TRF or EM-TRF-USV expansion module has been installed.
- Do not connect 230 V and 24 V supply voltages at the same time.
- Do not connect Terminals 1 + 2 with Comm 1 + 2.
- Never connect 24 V AC and 24 V DC supply voltage at the same time.
- Never connect the PC or Comm 1 + 2 to the connection (Fig. 4/18 - Terminal 3).

Notes on wiring

Use only cables that are designed for the supply voltage for which they will be used. The length and cross section as well as any contact resistance may increase voltage losses. The power rating of each unit must also be considered. A skilled qualified electrician has to select the correct cable types and sizes. This job must only be carried out by specialist electrical companies.

- For the electrical connection comply with any applicable regulations and follow the code of good practice. Be sure to comply with the applicable guidelines for working on electrical and electronic equipment as well as with any applicable local regulations.
- The connection data can be found on the rating plate or in the wiring diagrams.
- Protect any connecting cables from physical damage.
- Feed cables through the cable glands on the controller casing.
- Ensure that the device can be de-energised (all phases) for maintenance so that no voltage is present. This requires separators (e.g. fuses or RCBOs) near the controller; the contact gap should be at least 3 mm.

Additional information on wiring

See the following wiring documents:

- Wiring example, ☞ 31
- List of terminal connections, ☞ 36
- General wiring instructions TROX UNIVERSAL (separate document)
- Project-specific wiring documents, if any

Limited voltage supply

With a supply voltage of 24 V AC/DC, a maximum of 5 electronic controllers may be connected through the double terminals to limit the currents on the circuit board and the terminals.

Polarity of the power supply

When connecting the supply voltage, the polarity at 24 V AC and 24 V DC must be observed for all controllers!

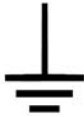
Functional earth

The controller is fitted with a functional earth connection. It is used to improve electromagnetic compatibility (EMC)

We recommend you to connect the device to equipotential bonding in order to improve electromagnetic compatibility.

Strain relief

Use the cable clips in the casing for all connection cables inside the casing.

Cabling

Be careful so as not to kink or disconnect the measuring tubes on the VAV air terminal unit.

8 Commissioning

Checking / adjusting the configuration settings

Controller parameters are factory set as ordered.

Carry out commissioning based on any project-specific data and the project-specific wiring documents..

Connection with configuration cable



Fig. 9: PC connection via various interfaces

- 1 Connection to terminal-1/2 (Service X2 / X3)
 - 2 Connection to the service socket of the BE-LCD control panel
1. ▶ Using a PC or notebook and the TROX EasyConnect configuration software, you can verify the configuration settings and adjust them if necessary.

To do this, connect the computer and the controller with the configuration cable (USB-RS485) to one of the interfaces shown above.

The required cables and adapters as well as the software license are available as accessories (part no. B588NF4).

Alternatively: BlueCon Bluetooth adapter



Fig. 10: Bluetooth connection via various interfaces

- 1 Connection to terminal-1/2 (Service X2 / X3)
 - 2 Connection to the service socket of the BE-LCD control panel
2. ▶ You can also establish a wireless connection (Bluetooth) between the controller and your PC. To do this, plug the BlueCON module into one of the interfaces shown above. This requires a Bluetooth interface on the PC or notebook (either integral hardware or external, e.g. with a USB stick).



Andriod APP EasyCon

Alternatively, diagnosis and maintenance can also be performed via an Android smartphone or tablet. The Android device can be used to access the controller via the BlueCon module.

The required EasyCon APP can be downloaded from Google PlayStore.

Zero point correction of the diaphragm pressure transducer



3. ▶ Zero point correction of the diaphragm pressure transducer is required as part of commissioning (not required for controllers with expansion module EM-AUTOZERO).

The EasyConnect software recognises the system configuration and guides you through the required steps. Zero point correction: Remove the two measuring tubes (blue and white) (1) from the angled pieces (2) on the sensor tube or from the T pieces (3) on the controller.



Zero point correction can alternatively also be carried out with the EasyCon APP.

When the zero point correction is finished, reconnect the measuring tubes.

Adaptation of the actuator (only for fast-running actuator TUS)



4. ▶ VAV terminal units with a TROX actuator NMQ24A-SR TR (M466EQ0) have to be adjusted as part of commissioning. This ensures that any incorrect position, e.g. due to shipping or installation, is corrected. To

adjust the actuator, press the green 'Adaption' button. The status LED lights up (orange) and the actuator is moved to its end position. When adjustment is complete, the status LED goes off.

Adaptation of the actuator (only for fast-running actuator TROX TUSD)



5. ▶ For air terminal units with TROX type HPD actuator (A00000067751), adaptation must be carried out during commissioning. This ensures that any incorrect position, e.g. due to shipping or installation, is corrected.

To do this, press the '*diagnostics*
→ *push button Adaption*' in the EasyConnect software.

For adaptation, the actuator moves to the end positions and then automatically switches to control mode.

Functional test

6. ▶ To complete commissioning, perform a functional test of the controller using the Easy-Connect software, taking into account the project specifications for the required operating modes.

Compare the volume flow rate setpoint value for each operating mode with the actual value and document the results. Check if alarms are emitted and signaled with the functional test.

9 Maintenance

Safety

The system owner is responsible for operational reliability.



DANGER!

Danger of death due to electric current!

Danger of electric shock! Do not touch any live components!

- Switch off the supply voltage and secure it against being switched on accidentally before working on the unit.
- Ensure that no voltage is present.
- Work on the electrical system must only be carried out by skilled qualified electricians.

Operation and maintenance

The electronic components of the controller do not require maintenance. Special maintenance requirements may apply to the VAV terminal unit depending on where it is installed.

Zero point correction

To ensure continued accuracy of volume flow measurements, zero point correction of the diaphragm pressure transducer is required in regular intervals (not required for controllers with expansion module EM-AUTOZERO). Carry out manual zero point correction at least once per year as part of a functional test or maintenance. Zero point correction is automatically carried out in regular intervals for controllers with expansion module EM AUTOZERO.



1. ▶ For manual zero point correction remove the two measuring tubes (blue and white) (1) from the angled piece (2) on the sensor tube or from the T pieces (3) on the controller.
2. ▶ Connect the controller to your PC or smartphone/tablet (EasyConnect software or EasyCon App required) see ↗ 25.
3. ▶ Start zero point correction with the software.

EasyConnect software	- Dialogue 'Diagnosis – I/O'
EasyCon App	- 'Zero point'
4. ▶ When the zero point correction is finished, reconnect the measuring tubes.

Blue	- Connection to – (Minus)
White	- Connection to + (Plus)

Replacing the fuse

If the glass fuse has blown, replace it only after the error has been diagnosed and solved. Replacement fuse ↪ *on page 9.*

10 Decommissioning

Removing the electronic controller



DANGER!

Danger of electric shock! Do not touch any live components!

Electrical equipment carries a dangerous electrical voltage.

- Only skilled qualified electricians are allowed to work on the electrical system.
- Switch off the power supply before working on any electrical equipment.

1. ▶ Interrupt the voltage supply to the controller.
2. ▶ Disconnect tubes and wires.
3. ▶ Detach the controller from the mounting bracket, ↪ *on page 20.*
4. ▶ Dispose of the controller in compliance with legal requirements.

Appendix

A Wiring example

A.1 Volume flow control

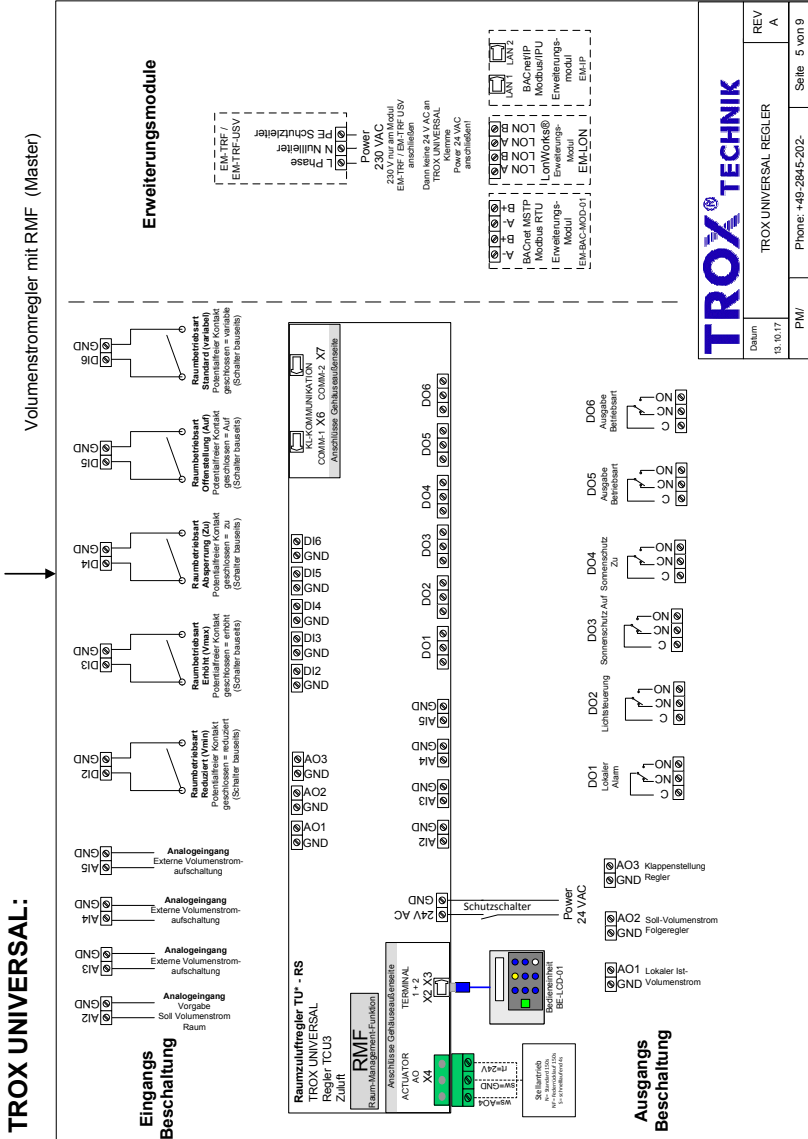

A.3 Duct pressure control

Kanaldruckregler mit RMF (Master)

TROX UNIVERSAL:

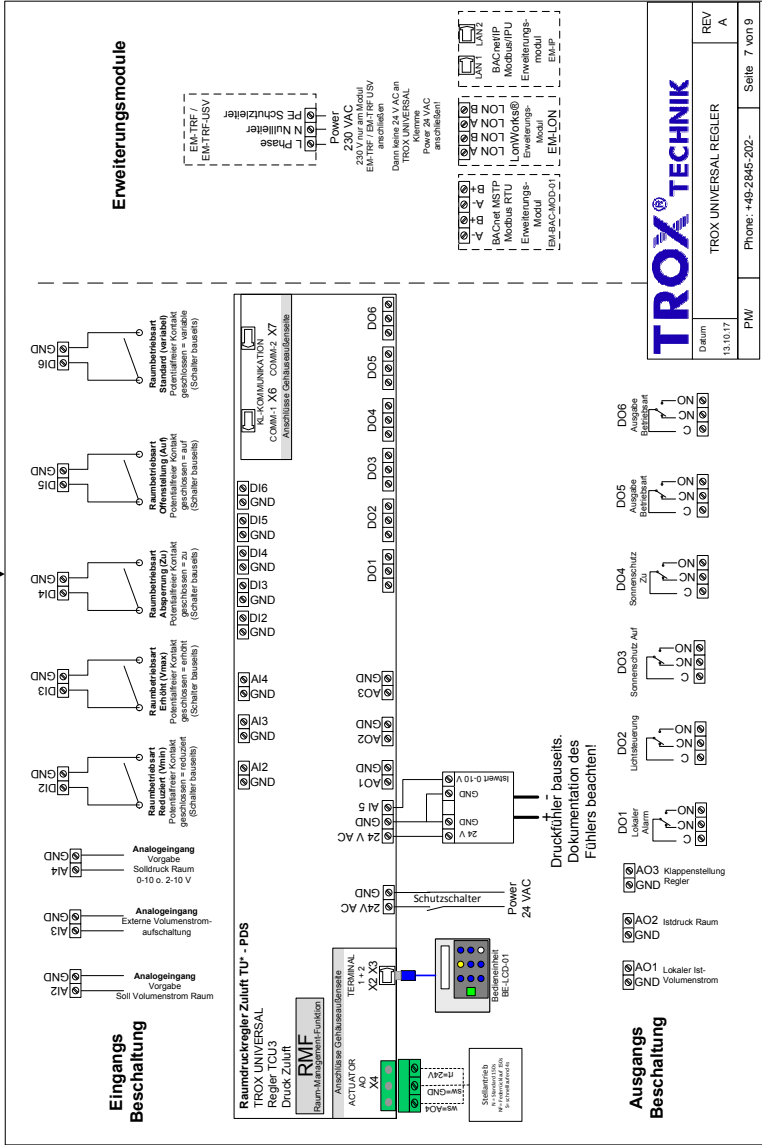

A.4 Volume flow control for supply air and extract air

TROX UNIVERSAL:

Volumenstromregelung Zu- & Abluft Master - Slave

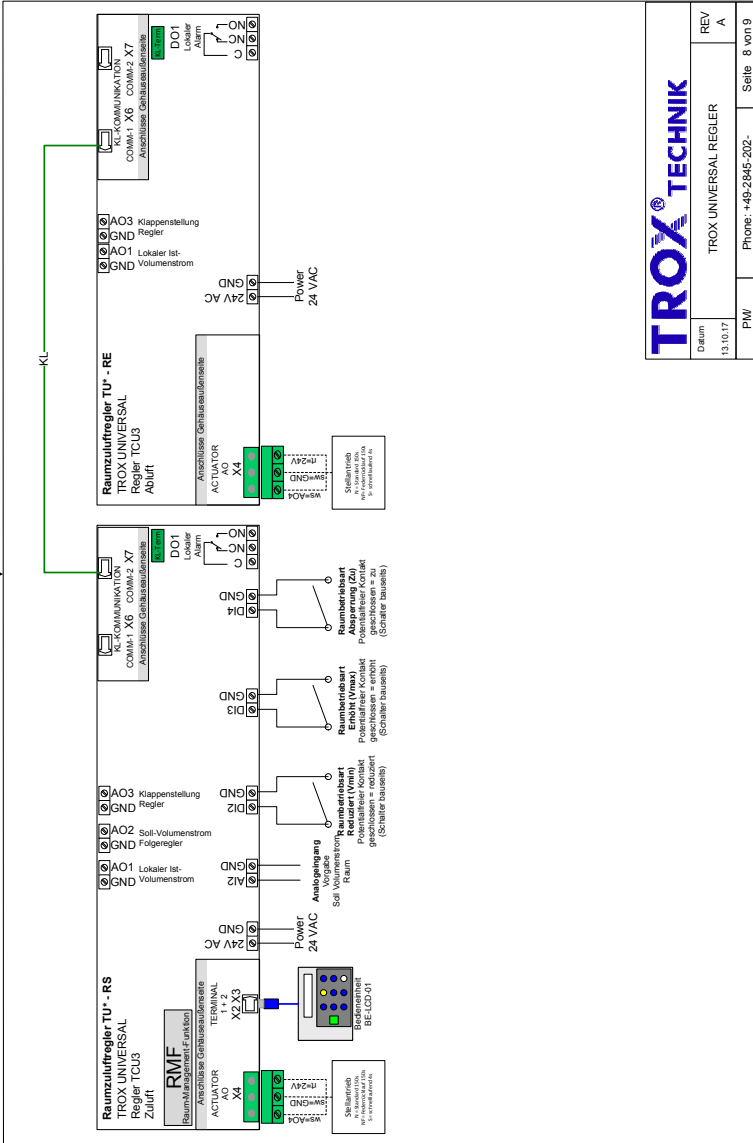

TROX® TECHNİK

Druck:	TROX UNIVERSAL REGLER	REV	A
Datum:	13.10.17	Seite:	8 von 9
PLW:	Phone: +49-2945-302-		

A.5 Volume flow control for supply air and extract air including room pressure control

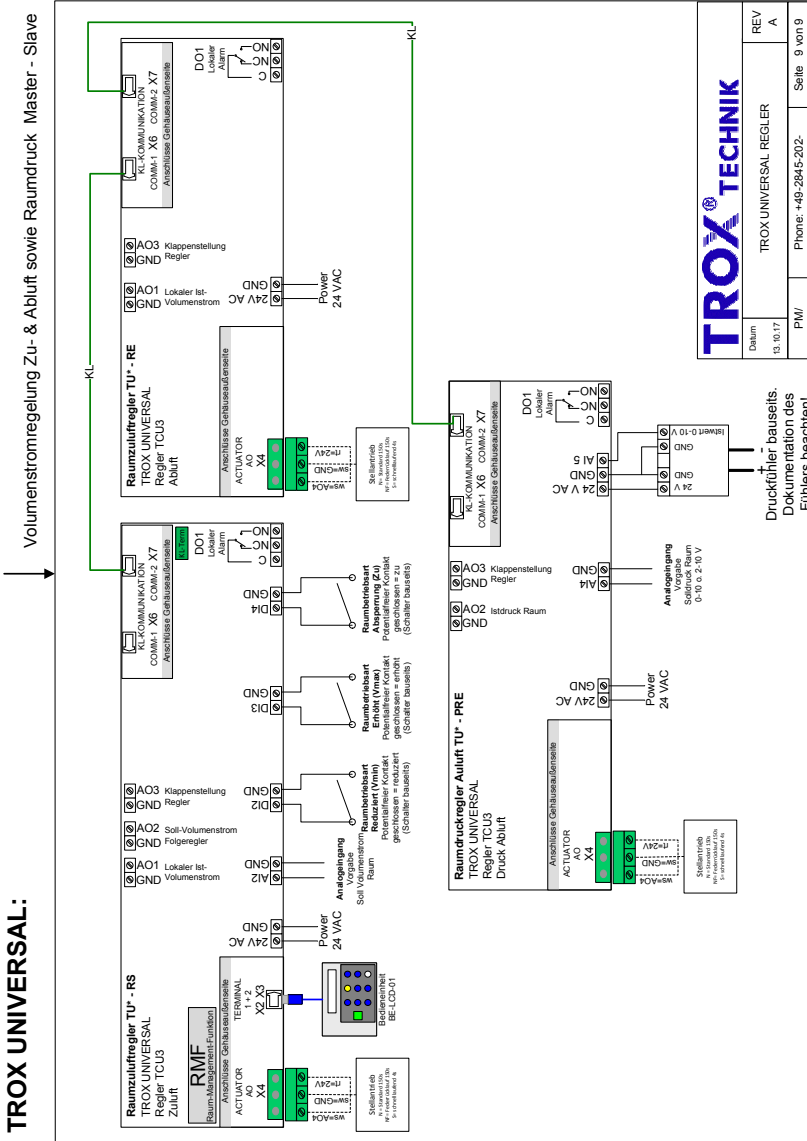

B List of terminal connections

Anschluss Connection	Aderquerschnitt Wire cross section	Aderanzahl No. of wires	Länge Length	max. Spannung Max. voltage	max. Strom Max. current	Max. Isolationsspannung Breakdown voltage of terminal
X4	0,2 – 2,5 mm ² / 12 – 30 AWG	3	1 m / 3,3 ft.	10 VDC	10 mA	1,6 kV
X1	digital Eingang DI	2 x 2 x 0,8	max. 100 m / 330 ft.	5 VDC	10 mA	1,6 kV
X2	26AWGx4p	8	max. 40 m / 131 ft.	24 VDC	200 mA	1000 VAC
X3	Terminal 2	26AWGx4p	max. 40 m / 131 ft.	24 VDC	200 mA	1000 VAC
X5	Sensor Eingang AIS	3 x 0,34	max. 10 m / 33 ft.	24 / 10 VDC	10 mA	1,6 kV
X6 / X7	Com1 / Com2	26AWGx4p	max. 300 m / 984 ft.	–	–	1000 VAC
DO1	NO/NC	0,2 – 2,5 mm ² / 12 – 30 AWG	–	230 VAC	8 A	1000 V
DO2	NO/NC	0,2 – 2,5 mm ² / 12 – 30 AWG	–	230 VAC	8 A	1000 V
DO3	NO/NC	0,2 – 2,5 mm ² / 12 – 30 AWG	–	230 VAC	8 A	1000 V
DO4	NO/NC	0,2 – 2,5 mm ² / 12 – 30 AWG	–	230 VAC	8 A	1000 V
DO5	NO/NC	0,2 – 2,5 mm ² / 12 – 30 AWG	–	230 VAC	8 A	1000 V
DO6	NO/NC	0,2 – 2,5 mm ² / 12 – 30 AWG	–	230 VAC	8 A	1000 V
DI2	DI2 – GND	0,14 – 1,5 mm ² / 16 – 26 AWG	max. 40 m / 131 ft.	5 V	10 mA	1,6 kV
DI3	DI3 – GND	0,14 – 1,5 mm ² / 16 – 26 AWG	max. 40 m / 131 ft.	5 V	10 mA	1,6 kV
DI4	DI4 – GND	0,14 – 1,5 mm ² / 16 – 26 AWG	max. 40 m / 131 ft.	5 V	10 mA	1,6 kV
DI5	DI5 – GND	0,14 – 1,5 mm ² / 16 – 26 AWG	max. 40 m / 131 ft.	5 V	10 mA	1,6 kV
DI6	DI6 – GND	0,14 – 1,5 mm ² / 16 – 26 AWG	max. 40 m / 131 ft.	5 V	10 mA	1,6 kV
AI1	Volumenstromsensor	0,14 – 1,5 mm ² / 16 – 26 AWG	max. 40 m / 131 ft.	10 V	10 mA	1,6 kV
AI2	24 VAC-AI2 – GND	0,14 – 1,5 mm ² / 16 – 26 AWG	max. 10 m / 33 ft.	10 VDC	10 mA	1,6 kV
AI3	AI3 – GND	0,14 – 1,5 mm ² / 16 – 26 AWG	–	–	–	1,6 kV
AI4	AI4 – GND	0,14 – 1,5 mm ² / 16 – 26 AWG	–	–	–	1,6 kV
AO1	AO1 – GND	0,14 – 1,5 mm ² / 16 – 26 AWG	max. 10 m / 33 ft.	10 VDC	10 mA	1,6 kV
AO2	AO2 – GND	0,14 – 1,5 mm ² / 16 – 26 AWG	–	–	–	1,6 kV
AO3	AO3 – GND	0,14 – 1,5 mm ² / 16 – 26 AWG	–	–	–	1,6 kV
TI	Temperaturingang	0,2 – 1,5 mm ² / 16 – 26 AWG	max. 10 m / 33 ft.	–	–	2,5 kV
24 V AC/DC	Spannungsversorgung	0,2 – 2,5 mm ² / 12 – 30 AWG	–	24 V AC/DC	2 A	1,6 kV