

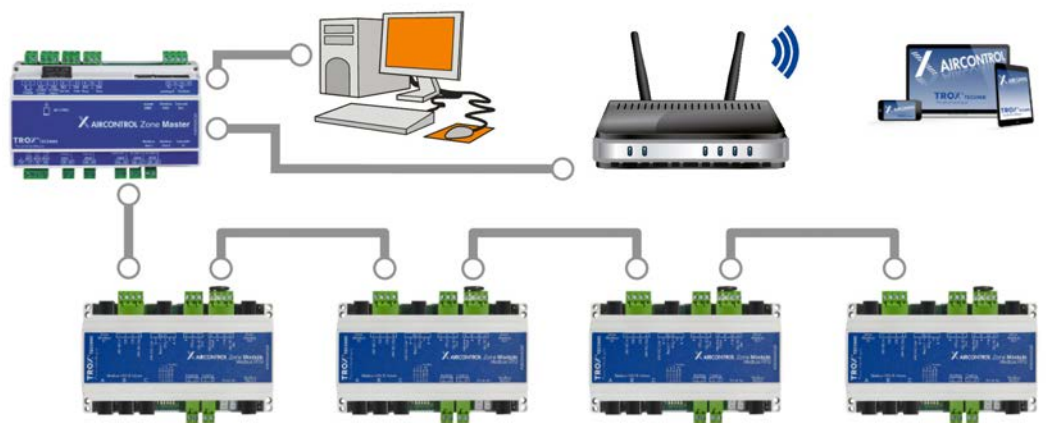

X-AIRCONTROL

Zone control systems



TROX[®] TECHNIK

The art of handling air

TROX GmbH
Heinrich-Trox-Platz
47504 Neukirchen-Vluyn, Germany
Germany
Telephone: +49 2845 202-0
Fax: +49 2845 202-265
Email: E-mail: trox@trox.de
Internet: www.trox.de

A00000063012, 2, GB/en
11/2021

© TROX GmbH 2017

About this manual

This manual enables operating or service personnel to use the X-AIRCONTROL zone control system safely and efficiently.

The manual must be kept near the zone control system to be available for use at all times.

This manual is intended for use by qualified electricians and network administrators.

It is essential that these individuals (§ 1.4 'Personnel requirements' on page 7) read and fully understand this manual before starting any work. The basic prerequisite for safe working is to comply with the safety notes and all instructions in this manual.

The local regulations for health and safety at work and the general safety regulations for the area of application of the zone control system also apply.

Illustrations in this manual are mainly for information and may differ from the actual design.

Other applicable documentation

In addition to these instructions, the following documents apply:

- Order confirmation
- Product drawings
- Data sheets for components from other suppliers, if any
- Additional drawings, if any
- X-AIRCONTROL operating manual
- X-AIRCONTROL installation manual
- X-CUBE operating manual
- X-CUBE installation manual
- X-CUBE compact operating manual
- X-CUBE compact installation manual
- Installation and commissioning manual for X-AIRCONTROL accessories
- Volume flow controller installation manual
- Volume flow controller operating manual

TROX Technical Service

To ensure that your request is processed as quickly as possible, please keep the following information ready:

- Product name
- TROX order number
- Delivery date
- Brief description of the fault

Online	www.troxtechnik.com
Phone	+49 2845 202-400

Copyright

This document, including all illustrations, is protected by copyright and pertains only to the corresponding product.

Any use without our consent may be an infringement of copyright, and the violator will be held liable for any damage.

This applies in particular to:

- Publishing content
- Copying content
- Translating content
- Microcopying content
- Saving content to electronic systems and editing it

Limitation of liability

The information in this manual has been compiled with reference to the applicable standards and guidelines, the state of the art, and our expertise and experience of many years.

The manufacturer does not accept any liability for damages resulting from:

- Non-compliance with this manual
- Incorrect use
- Operation or handling by untrained individuals
- Unauthorised modifications
- Technical changes
- Use of non-approved replacement parts

The actual scope of delivery may differ from the information in this manual for bespoke constructions, additional order options or as a result of recent technical changes.

The obligations agreed in the order, the general terms and conditions, the manufacturer's terms of delivery, and the legal regulations in effect at the time the contract is signed shall apply.

We reserve the right to make technical changes.

Warranty claims

The provisions of the respective general delivery terms apply to warranty claims. For purchase orders placed with TROX GmbH, these are the regulations in section "VI. Warranty claims" of the Delivery Terms of TROX GmbH, see www.trox.de/en/.

1	Safety	6	4	Configuring system components on the control panel	74
	1.1 Symbols used in this manual	6		4.1 Switching the control panel on	74
	1.2 Correct use	6		4.2 Start screen functions	74
	1.3 System owner's responsibility	7		4.3 Setting up the X-AIR-CP-2T control panel	76
	1.4 Personnel requirements	7		4.3.1 Password entry	76
	1.5 Work area hazards	8		4.3.2 Selecting a language	76
	1.5.1 Electric shock hazard	8		4.3.3 Setting the date	76
	1.5.2 Risks from rotating parts	8		4.3.4 Setting the time	77
	1.5.3 Risks from hot surfaces	8		4.3.5 Showing or hiding the main menu	77
	1.5.4 Health risk due to hygiene issues	8		4.4 Configuring a zone module	78
	1.5.5 Incorrect troubleshooting	8		4.4.1 Setting the configuration mode	78
	1.6 Personal protective equipment	8		4.4.2 Activating a frost or window contact	78
2	X-AIRCONTROL system description	10		4.4.3 Setting an override timeout	79
	2.1 System variants	10		4.4.4 Setting up schedules	79
	2.1.1 Single room control (stand-alone)	10		4.4.5 Setting room data	82
	2.1.2 Control of up to 25 rooms	12		4.4.6 Setting the volume flow rate for a room	82
	2.1.3 Control with 5 zone masters	13		4.4.7 Setting the screen saver activation time	83
	2.1.4 Control of up to 4 rooms with an X-CUBE compact	14		4.4.8 Setting PI values	83
	2.2 System components	15		4.5 Using the zone module	84
	2.2.1 Zone master	15		4.5.1 Setting the volume flow rate	84
	2.2.2 Zone modules	19		4.5.2 Setting a temperature setpoint value	85
	2.2.3 Room control panel X-AIR-CP-2T	31		4.6 Viewing system settings	85
	2.2.4 Room control panel X-AIR-CP-TS	33		4.6.1 Viewing room air temperatures	85
	2.2.5 Sensors	34		4.6.2 Viewing the volume flow rate for a room	86
3	Setting up system components on the web-server	45		4.6.3 Viewing system information	86
	3.1 Configuring the network access	45		4.6.4 Help	86
	3.2 Start screen functions	46		4.6.5 Displaying alarms	87
	3.3 Selecting a language	47	5	Commissioning X-AIRCONTROL	88
	3.4 Logging in to the webserver	48		5.1 Commissioning a stand-alone zone module	88
	3.5 Setting date and time on the webserver ..	49		5.2 Commissioning a zone module on a zone master	88
	3.6 Displaying the service screen	49	6	Integrating X-AIRCONTROL with a central BMS	90
	3.7 Zone overview	50	7	Connecting X-AIRCONTROL to an air handling unit (AHU)	91
	3.8 Configuring zone modules	51	8	Setting up MP bus or Modbus actuators	92
	3.8.1 Activating the device detection mode ..	51		8.1 Addressing MP bus or Modbus actuators	92
	3.8.2 Configuring actuators and sensors	53		8.2 LEDs on MP bus or Modbus actuators	92
	3.8.3 Setting the volume flow rate	54		8.3 Configuring MP bus or Modbus actuators	92
	3.8.4 Checking the volume flow rate	54	9	Troubleshooting	96
	3.8.5 Setting up a supply branch	55		9.1 Safe troubleshooting	96
	3.8.6 Setting up an extract branch	56		9.2 Alarms displayed on the control panel	96
	3.8.7 Zone grouping	57		9.3 Alarms displayed on the webserver	100
	3.8.8 Hotel mode	58			
	3.8.9 Setting zone values	58			
	3.8.10 Configuring the zone master	65			
	3.8.11 Summer and winter compensation	71			
	3.8.12 Network connection settings	71			
	3.8.13 Firmware update	72			
	3.8.14 Displaying a zone overview	73			

10	Wiring documents	104
10.1	Zone master	104
10.2	Zone module X-AIR-ZMO-MP	105
10.3	Zone module X-AIR-ZMO-MOD	106
10.4	Zone module X-AIR-ZMO-ANA	107
11	Index.....	108

1 Safety

1.1 Symbols used in this manual

Safety notes

Symbols are used in this manual to alert readers to areas of potential hazard. Signal words express the degree of the hazard.

Comply with all safety instructions and proceed carefully to avoid accidents, injuries and damage to property.

DANGER!

Imminently hazardous situation which, if not avoided, will result in death or serious injury.

WARNING!

Potentially hazardous situation which, if not avoided, may result in death or serious injury.

CAUTION!

Potentially hazardous situation which, if not avoided, may result in minor or moderate injury.

NOTICE!

Potentially hazardous situation which, if not avoided, may result in property damage.

ENVIRONMENT!

Environmental pollution hazard.

Tips and recommendations



Useful tips and recommendations as well as information for efficient and fault-free operation.

Specific safety notes

The following symbols are used in safety notes to alert you to specific hazards:

Warning signs	Type of danger
	Warning – danger zone.

Additional markers

In order to highlight instructions, results, lists, references and other elements, the following markers are used in this manual:

Marker	Explanation
1., 2., 3. ...	Step-by-step instructions
	Results of actions
	References to sections in this manual and to other applicable documents
	Lists without a defined sequence
[Switch]	Operating elements (e.g. push buttons, switches), display elements (e.g. LEDs)
'Display'	Screen elements (e.g. buttons or menus)

1.2 Correct use

The X-AIRCONTROL zone control system consists of a zone master and several zone modules plus sensors; it is designed exclusively for the configuration, adjustment and monitoring of ventilation and air conditioning systems in buildings and in individual rooms.

Incorrect use

WARNING!

Danger due to incorrect use!

Incorrect use of X-AIRCONTROL can lead to dangerous situations.

- Do not use the system as a replacement for required regular inspections, i.e. do not skip inspections that are stipulated in building regulations.
- Do not use the system for fire protection or smoke extract purposes.
- Do not use the system in rooms with explosive gases.
- Do not use the system in wet areas.
- Do not use the system with sensors or accessories provided by others.
- Do not use the signals of the volt-free outputs for safety functions.

1.3 System owner's responsibility

System owner

The system owner is a natural or legal person who for commercial or business purposes owns or manages X-AIRCONTROL or allows third parties to use or operate it, but continues to bear legal responsibility for the safety of users, staff or third parties while the product is in use.

System owner's obligations

The system is intended for commercial use. The system owner is therefore subject to the legal obligations of occupational health and safety regulations.

In addition to the safety notes in this manual, the applicable regulations for safety, accident prevention and environmental protection must also be complied with.

In particular:

- The system owner must be aware of the applicable occupational health and safety regulations and carry out a risk assessment to determine any additional hazards that may exist or result from the specific working conditions at the installation location of X-AIRCONTROL. The system owner has to create operating instructions for X-AIRCONTROL that reflect the results of this risk assessment.
- The system owner has to ensure, throughout the entire operating period of X-AIRCONTROL, that these operating instructions conform to applicable standards and guidelines; in case of any deviation, the system owner has to adapt the instructions.
- The system owner must name responsible persons for commissioning and service of the system.
- The system owner has to ensure that all individuals who handle or use X-AIRCONTROL have read and understood this manual.
- The system owner must regularly provide training for the personnel and inform them of any dangers.
- The system owner must provide the employees with the required personal protective equipment.
- The system owner must have all safeguards tested regularly to ensure that they are functional and complete.
- The system owner must observe the local fire regulations.

1.4 Personnel requirements

Qualification

WARNING!

Danger of injury or risk of damage to property due to insufficiently qualified individuals!

Insufficiently qualified individuals are not aware of the risks involved in working with this system and its components and are hence likely to put themselves or others into danger, causing severe or fatal injuries.

- Have any work carried out only by qualified personnel.
- Keep insufficiently qualified individuals away from the work area.

The work described in this manual has to be carried out by individuals with the qualification, training, knowledge and experience described below:

HVAC technician

HVAC technicians are individuals who have sufficient professional or technical training in the field they are working in to enable them to carry out their assigned duties at the level of responsibility allocated to them and in compliance with the relevant guidelines, safety regulations and instructions. HVAC technicians are individuals who have in-depth knowledge and skills related to HVAC systems; they are also responsible for the professional completion of the work under consideration.

HVAC technicians are individuals who have sufficient professional or technical training, knowledge and actual experience to enable them to work on HVAC systems, understand any potential hazards related to the work under consideration, and recognise and avoid any risks involved.

Network administrator

Network administrators design, install, configure and maintain the IT infrastructure in companies or organisations.

Skilled qualified electrician

Skilled qualified electricians are individuals who have sufficient professional or technical training, knowledge and actual experience to enable them to work on electrical systems, understand any potential hazards related to the work under consideration, and recognise and avoid any risks involved.



Any work has to be carried out by individuals who can be expected to carry out their assigned duties reliably. Individuals whose reaction time is delayed due to alcohol, drugs or other medication must not carry out any work.

Passwords

Some software functions are password protected to prevent unauthorised individuals from entering or changing data (↪ 3.4 'Logging in to the webserver' on page 48 , ↪ 4.3.1 'Password entry' on page 76).

1.5 Work area hazards

1.5.1 Electric shock hazard

Electric current

DANGER!

Danger of death due to electric current!

Danger of electric shock! Do not touch any live components! Damaged insulation or damaged parts are a life threatening hazard.

- Only skilled qualified electricians must work on the electrical systems.
- If the insulation is damaged, disconnect the power supply immediately and have the insulation repaired.
- Before you start any service jobs, ensure that no voltage is present.
- Ensure that live parts do not come into contact with moisture. Moisture can cause a short circuit.

1.5.2 Risks from rotating parts

Rotating parts

WARNING!

Risk of injury from rotating parts!

Rotating parts in the fan can cause serious injuries.

- Before you start any service jobs, interrupt the power supply.
- Do not reach into the moving fan.
- The fan does not stop immediately! Check that no parts are moving once you have opened the casing cover.
- Do not open the casing cover while the fan is in operation.

1.5.3 Risks from hot surfaces

Hot surfaces

WARNING!

Risk of burns from hot surfaces!

Skin contact with hot surfaces causes severe skin burns.

- Before you start any service jobs on the electric duct heater, interrupt the power supply.
- Wait for 10 minutes after you have pulled the mains plug.
- Before you start working, make sure that all surfaces have cooled down to ambient temperature.

1.5.4 Health risk due to hygiene issues

Hygiene issues

CAUTION!

Health risk due to hygiene issues!

When the unit is not used for several weeks, bacteriae and germs may start growing in the air filter and in the recuperative heat exchanger.

- Change the air filters and clean the recuperative heat exchanger after lengthy idle periods.
- Change filters and clean the recuperative heat exchanger in the recommended intervals.

1.5.5 Incorrect troubleshooting

WARNING!

Risk of injury from incorrect troubleshooting!

Incorrect troubleshooting can cause serious injuries and considerable damage to property.

- In case of any error or fault on the ventilation unit, first pull the mains plug.
- Faults that cannot be rectified according to the instructions in the 'Troubleshooting' section have to be rectified by the TROX Technical Service.
- Do not open the casing cover while the ventilation unit is in operation.

1.6 Personal protective equipment

WARNING!

Health risk due to inadequate personal protective equipment!

- Ensure that personnel uses the correct personal protective equipment for the location where the zone control system is installed.

Personal protective equipment is equipment that protects the user against health or safety risks at work.

The personal protective equipment (type etc.) required for a job depends on the installation location and the ambient conditions.

The system owner has to provide the correct personal protective equipment for each commissioning and service job.

If the system owner does not provide any personal protective equipment, at least the following equipment has to be used:

Industrial safety helmet



Industrial safety helmets protect the head from falling objects, suspended loads, and the effects of striking the head against stationary objects.

Protective clothing



Protective clothing is close-fitting, with low tear resistance, close-fitting sleeves, and no projecting parts. It prevents entanglement in moving machinery.

Safety shoes



Safety shoes protect the feet against crushing, falling parts, and from slipping on slippery ground.

Safety goggles



Safety goggles protect the eyes from flying particles and liquid splashes.

Protective gloves



Protective gloves protect hands from friction, abrasions, punctures and deep cuts.

2 X-AIRCONTROL system description

2.1 System variants

2.1.1 Single room control (stand-alone)

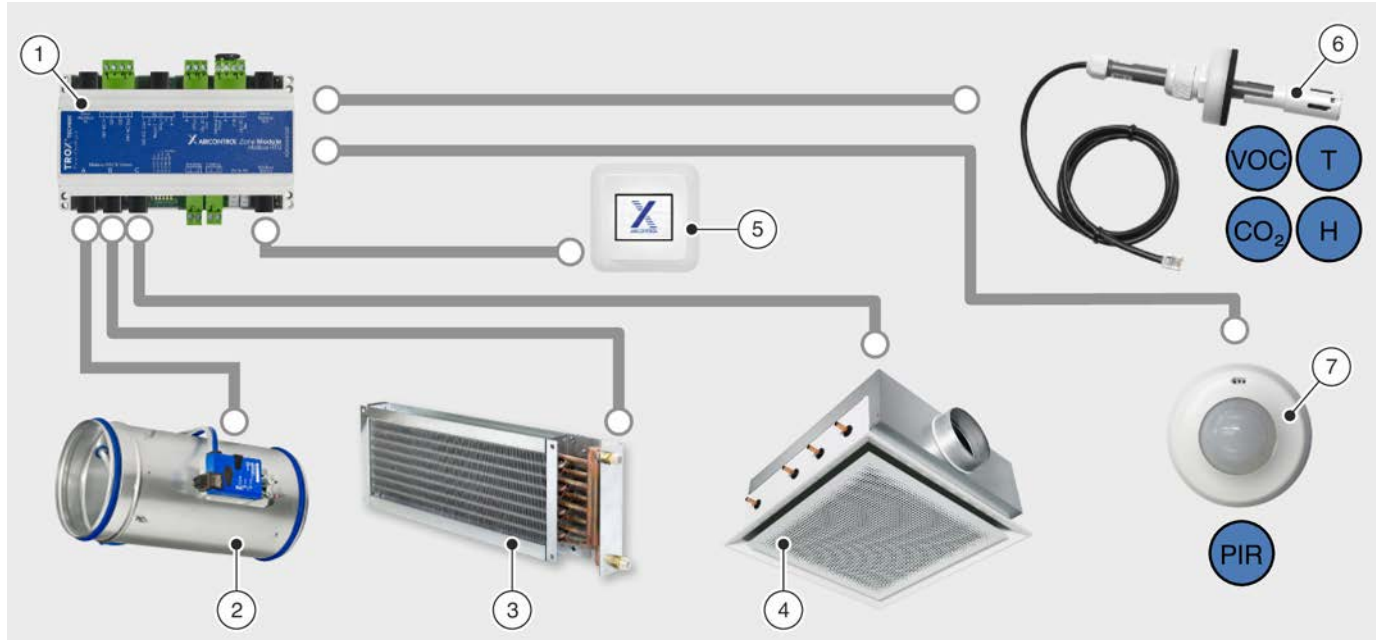

Fig. 1: Single room control

- | | | | |
|---|----------------------------------|---|---|
| 1 | Zone module | 5 | Room control panel |
| 2 | Supply air / extract air control | 6 | Sensors for temperature, humidity, CO ₂ /VOC |
| 3 | Heating | 7 | Motion detector (PIR sensor) |
| 4 | Cooling | | |

Single room control is the smallest unit for X-AIRCONTROL. With this setup, one zone module controls one zone (e.g. a room). Zone modules come in three variants. Make sure that each VAV terminal unit and controller fit the bus system used for the zone module.

Zone modules

- X-AIR-ZMO-ANA
(↪ 2.2.2.3 'Zone module X-AIR-ZMO-ANA' on page 28)
- X-AIR-ZMO-MP
(↪ 2.2.2.1 'Zone module X-AIR-ZMO-MP' on page 22)
- X-AIR-ZMO-MOD
(↪ 2.2.2.2 'Zone module X-AIR-ZMO-MOD' on page 25)

Requirements

- Installation on a standard 35 mm mounting rail (to DIN standard)
- Casing suitable for the classification of the installation location
(↪ 2.2.2.4 'Zone module X-AIR-ZMO-COVER' on page 31)
- 24 V AC supply voltage (by others)
- No more than 3 zone modules connected to 1 power supply
- Control panel X-AIR-CP-2T (2" touch panel)
(↪ 2.2.3 'Room control panel X-AIR-CP-2T' on page 31)

Application

- Temperature control (heating/cooling)
 - Room temperature control / extract air temperature control
- Volume flow rate control (temperature, humidity, CO₂/VOC)
 - Room temperature control / extract air temperature control
 - Room humidity control / Extract air humidity control
 - Room/extract air/CO₂ control or VOC control
- Timer programmes
 - Week timer with up to 4 switching times per day
 - Real time clock
- Additional functions
 - Window contact/dew point sensor or frost protection sensor
 - Motion detector (PIR sensor)

Operating modes

- Automatic mode
Zones are automatically controlled based on measured values and based on demand.
- Minimum volume flow rate
The set minimum volume flow rates are maintained. Temperature control by means of water-side valves is not affected.
- Maximum volume flow rate
The set maximum volume flow rates are maintained. Temperature control by means of water-side valves is not affected.

2.1.2 Control of up to 25 rooms

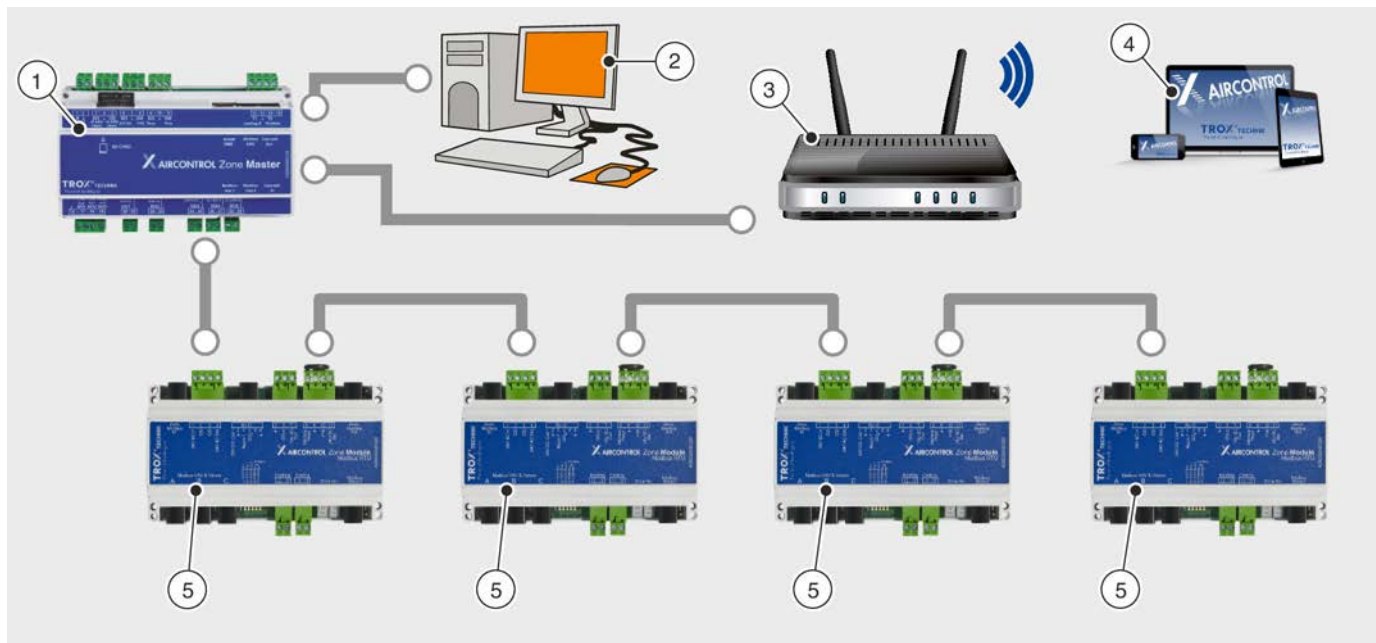

Fig. 2: Control of up to 25 rooms

- | | | | |
|---|----------------|---|---------------------------------|
| 1 | Zone master | 4 | X-AIRCONTROL software/webserver |
| 2 | Central BMS | 5 | Zone modules |
| 3 | Network access | | |

You can connect up to 25 zone modules to a zone master (Fig. 2 /1) and hence control them centrally. For system commissioning and configuration you can use the webserver that is included in the zone master.

Requirements

- Works only with X-AIR-ZMAS zone master
- Configuration and commissioning with webserver using a personal computer or notebook
- Control of several zones using the zone master as a higher-level interface for data exchange, configuration and display
- Up to 25 zone modules connected to one zone master (section)
- Zone bus as daisy chain

Application

- Same as stand-alone version, 10

Additional application functions

- Override control for maximum or minimum volume flow rate
- Duct pressure monitoring
- Summer and winter compensation
- Hotel mode
- Zone grouping
- Fire mode

Operating modes

- Automatic mode
Zones are automatically controlled based on measured values and based on demand.
- Minimum volume flow rate
The set minimum volume flow rates are maintained. Temperature control by means of water-side valves is not affected.
- Maximum volume flow rate
The set maximum volume flow rates are maintained. Temperature control by means of water-side valves is not affected.

2.1.3 Control with 5 zone masters

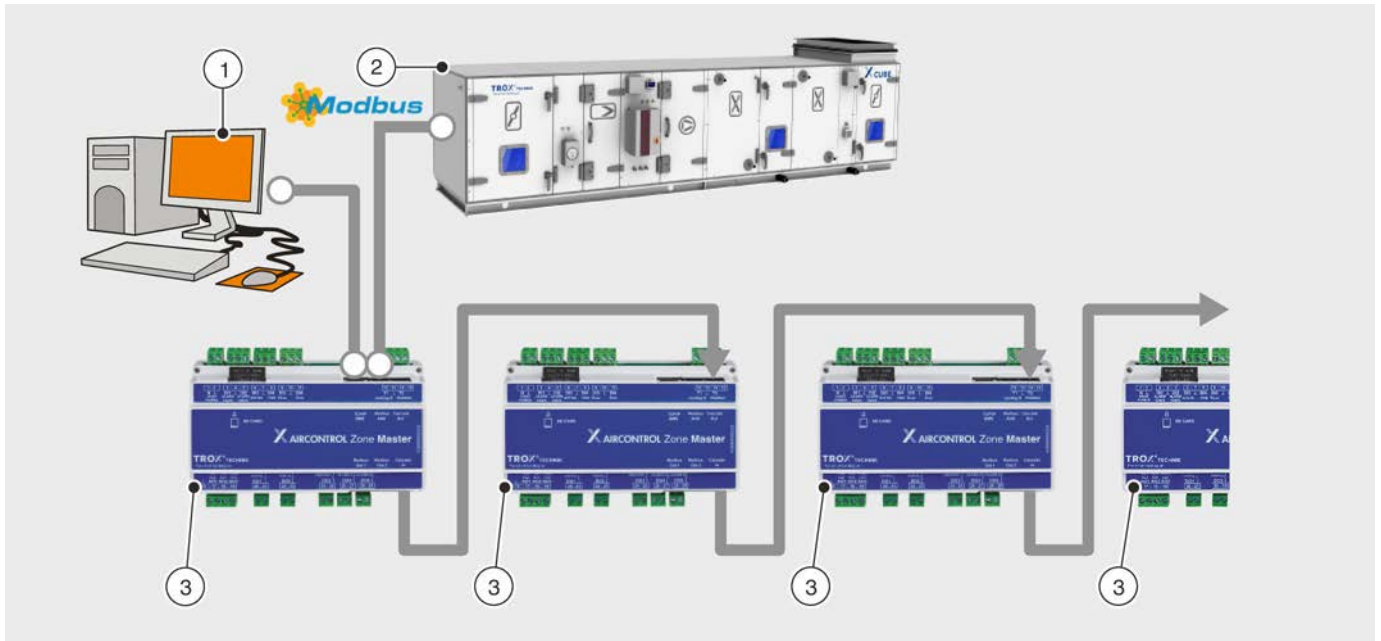

Fig. 3: Control with 5 zone masters

- 1 Central BMS
- 2 Air handling unit (Modbus RTU)
- 3 X-AIRCONTROL zone master

Requirement

- No more than 5 zone masters, cascading

You can connect up to five X-AIRCONTROL zone masters to form a system. You then have to connect the zone masters in a cascade between the 'Zone Master In' input and the 'Zone Master Out' output. You need to connect each X-AIRCONTROL zone master to the same LAN (subnetwork) so that the web server acts as the common interface.

Each of the five X-AIRCONTROL zone masters requires a separate IP address.

Example:

X-AIRCONTROL zone master	IP address
Section 1	192.168.0.201 (factory setting)
Section 2	192.168.0.202
Section 3	192.168.0.203
Section 4	192.168.0.204
Section 5	192.168.0.205

2.1.4 Control of up to 4 rooms with an X-CUBE compact

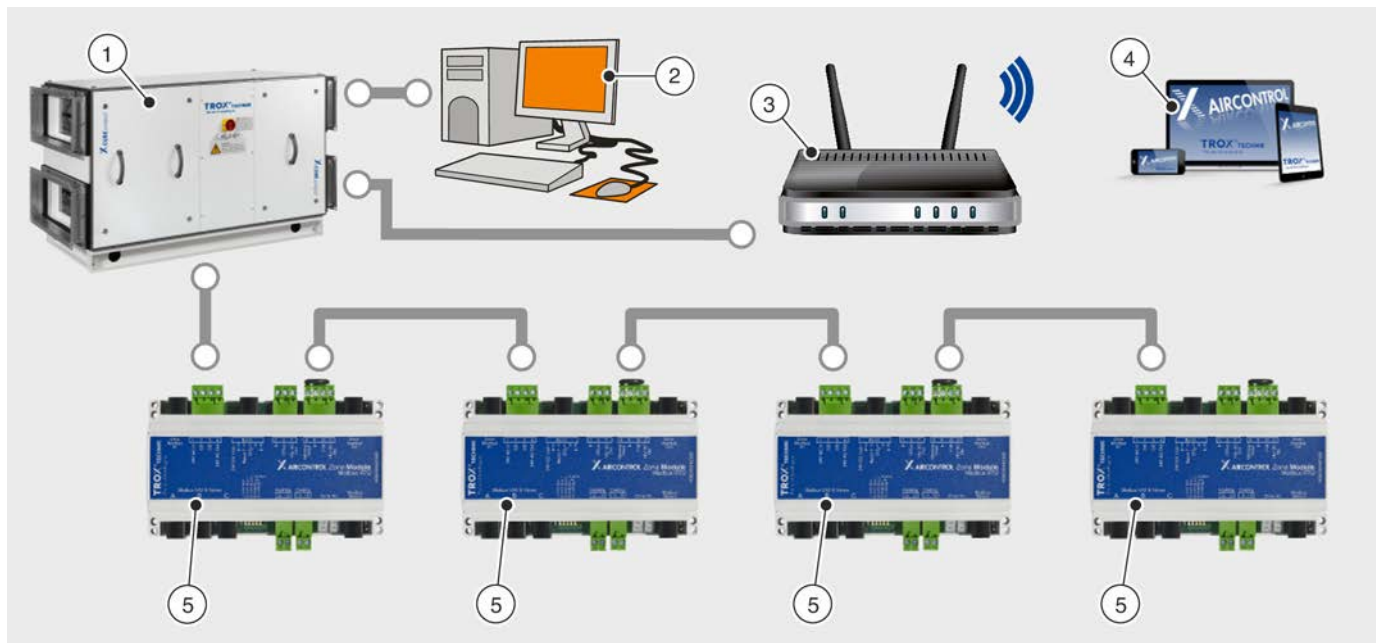

Fig. 4: Control of up to 4 rooms with an X-CUBE compact

- | | |
|------------------------------------|-------------------------|
| 1 X-CUBE compact air handling unit | 4 X-AIRCONTROL software |
| 2 Central BMS | 5 Zone modules |
| 3 Network access | |

You can use an X-CUBE compact air handling unit to control an X-AIRCONTROL system for up to 4 zones (rooms). In such a case, X-CUBE control (AHU control system) provides the control input signals for fans, volume flow controllers and peripheral components. You can interconnect up to 4 zone modules and control them individually. The X-AIRCONTROL software allows you to configure X-CUBE compact and each zone module using the X-CUBE control Ethernet interface. X-CUBE control is an integral part of the X-CUBE compact air handling unit.

- The X-AIRCONTROL zone master function is included in X-CUBE control
- Up to 4 zone modules of any type can be connected
- Configuration is done using the integral webserver
- Remote maintenance is possible (central BMS)

2.2 System components

2.2.1 Zone master



Fig. 5: X-AIRCONTROL zone master

- | | |
|---|--|
| <ul style="list-style-type: none"> 1 Supply voltage 24 V AC (G0/G) 2 Alarm inputs (DI1/DI2) 3 External activation and fire alarm (DI3/DI4) 4 Override control to maintain the volume flow rate setpoint, either V_{min} or V_{max} (DI5/DI6) 5 Cooling circuit ('cooling flow') temperature sensor/ outdoor sensor (T1/T2) 6 Network interfaces (TCP/IP, BMS/Modbus AHU/ Zone Master Out) 7 Network interfaces (Modbus Out 1/Modbus Out 2/ Zone Master In) | <ul style="list-style-type: none"> 8 Digital output signal 'B alarm' (DO5) 9 Digital output signal 'A alarm' (DO4) 10 Operation (DO3) 11 Activation of heating function (DO2) 12 Activation of cooling function (DO1) 13 Control signal for supply air fan/extract air fan/ cooling circuit (AO1/AO2/AO3) 14 Slot for SD card |
|---|--|

Connections

Analogue output signals (0 – 10 V) (AO1, AO2, AO3)	Terminal no.	
AO1 (Fan Sup)	17	Control signal for a central supply air fan
AO2 (Fan Exh)	18	Control signal for a central extract air fan
AO3 (Pump Cool)	19	Control signal for the cooling circuit (e.g. circulator pump)
⊥	16	GND

Digital output signals (DO1, DO2, DO3, DO4, DO5)	Terminal no.	
DO1 (Cooling)	20 - 21	Activation of cooling function
DO2 (Heating)	22 - 23	Activation of heating function
DO3 (Operate)	24 - 25	Operation
DO4 (Alarm)	26 - 27	A alarm
DO5 (Alarm)	28 - 29	B alarm

Supply voltage (G0/G)	Terminal no.	
G0	1	Supply voltage 24 V AC
G	2	

Digital input signals (DI1, DI2, DI3, DI4, DI5, DI6)	Terminal no.	
DI1 (Alarm Fan Sup)	3	Supply air fan alarm input
⊥	4	GND
DI2 (Alarm Fan Exh)	5	Extract air fan alarm input
DI3 (Ext. Enable)	6	External activation (e.g. signal from central BMS) that enables zone controllers to work in auto mode
⊥	7	GND
DI4 (FIRE)	8	Fire alarm (override control of supply and extract air flow controllers in the event of a fire)
DI5 (\check{V}_{max})	9	Override control: volume flow controllers maintain V_{max}
⊥	10	GND
DI6 (\check{V}_{min})	11	Override control: volume flow controllers maintain V_{min}

Temperature sensor connections (T1, T2)	Terminal no.	
T1 (Cooling flow)	12	Temperature sensor of cooling circuit
⊥	13	GND
T2 (Outdoor)	14	Outdoor sensor
–	15	Not used

SD interface	Terminal no.	
SD card	–	Slot for SD card

Communication interfaces	Terminal no.	
TCP/IP, BMS	–	Connection to a TCP/IP network (RJ45 socket)
Modbus AHU	–	Connection to an air handling unit (RS485 socket)
Zonemaster Out	–	Connection for cascading (only zone master)

Communication interfaces	Terminal no.	
Modbus Out 1	–	'Zone Modbus Out' for the connection of zone modules
Modbus Out 2	–	'Zone Modbus Out' for the connection of zone modules
Zonemaster In	–	Connection for cascading (only zone master)

Technical data

Dimensions and weight	
Width	156 mm
Height	110 mm
Depth	58 mm
Weight	430 g

Electrical data	
Supply voltage	24 V AC \pm 10%
Power consumption (master)	\leq 5 VA (without any external sensors or actuators)
Cable diameter	1.5 mm ² max.
SD card	SDHC, 8 GB max.

Network properties	
IP address	192.168.0.201 (factory setting)
Subnet	255.255.255.0 (factory setting)

Network properties	
TCP/IP connections	RJ45 plug (8P8C) 10/100 Mbit Ethernet
Modbus communication	5 x RJ12 plugs (6P/6C) Modbus Out1 / Out2: RS-485; 38.4 kBd Modbus Master In / Master Out: RS-485; 38.4 kBd Modbus AHU: RS-485; Baud rate: 4800 Bd, 9600 Bd, 19200 Bd, 38400 Bd; 8 data bits; parity: no/even/uneven; 1 or 2 stop bits; address: 1 - 240
Length of cable to modules	Cable type: Telephone ribbon cable 6-core with RJ12 plugs (6P/6C) 100 m max.
Length of cable to master	Cable type: Telephone ribbon cable 6-core with RJ12 plugs (6P/6C) 100 m max.

Inputs/outputs	
Digital inputs [DI1 DI2 DI3 DI4 DI5 DI6]	6 × pull-up with ground contact
Digital outputs [DO1 DO2]	2 x max. 5 A/230 V
Digital outputs [DO3 DO4 DO5]	3 x 5 A/30 V max.
Sensor inputs [T1 T2]	2 x for PT1000
Analogue outputs [AO1 AO2 AO3]	3 x 0 – 10 V DC Max. load: 50 mA per output

Ambient conditions	
Acceptable relative humidity (rh)	10 – 90 % (no condensation)
Max. temperature – operation	-20 to +50 °C
Max. temperature – storage	-30 to +70 °C
Protection level	IP 20 (EN 60529)

2.2.2 Zone modules

Connections found on all zone modules

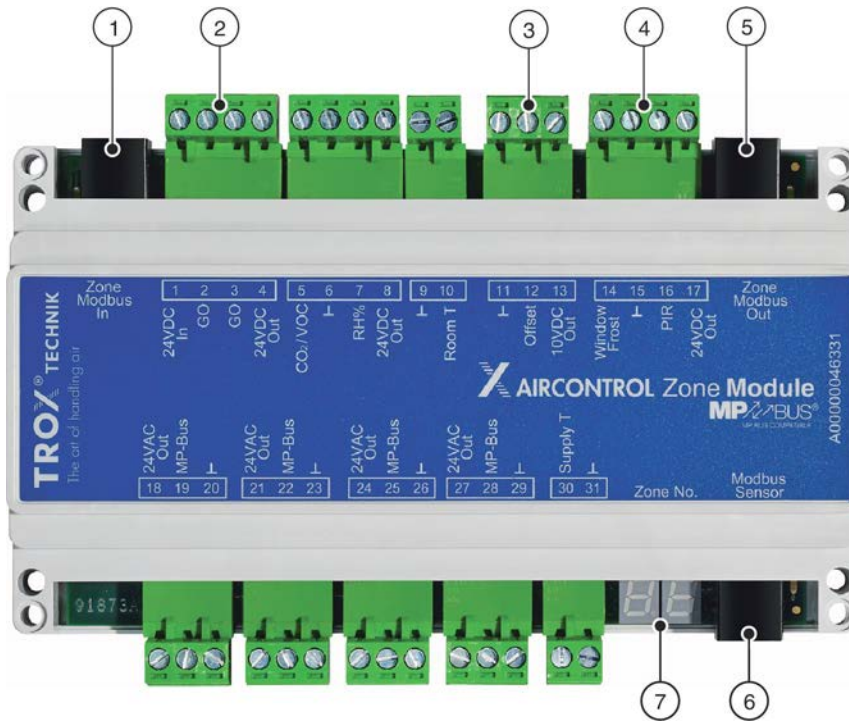

Fig. 6: Zone module

- | | |
|--|---------------------------------|
| 1 Zone Modbus connection input | 5 Zone Modbus connection output |
| 2 Supply voltage 24 V AC (In/G0/G0/Out) | 6 Modbus sensor |
| 3 Analogue input for setpoint value (±/Offset/10 V DC Out) | 7 7-segment display |
| 4 Digital input for window contact/frost protection sensor/motion detector (PIR) | |

The connections in Fig. 6 /1 – 6 and the 7-segment display (Fig. 6 /7) are included in all zone modules and have the same functions.

Connections

Communication interfaces	Terminal no.	
Modbus sensor	RJ12 socket	Various sensors and room control panel X-AIR-CP-2T
Zone Modbus In	RJ12 socket	Connection to the zone master or to the preceding zone module

Supply voltage (G0)	Terminal no.	
24 V AC In	1	Input for supply voltage 24 V AC
G0	2	
G0	3	
24 V AC Out	4	Output of supply voltage 24 V AC to the following zone module (up to 3 in series)

Analogue input for setpoint values	Terminal no.	
⊥	5	GND for analogue setpoint adjuster
Offset	6	Analogue input for setpoint value
10 V DC Out	7	Supply voltage for analogue setpoint adjuster, load: 10 mA max.

Digital input signals	Terminal no.	
Windows/Frost	8	Digital input for window contact/frost protection sensor
⊥	9	GND for window contact/frost protection contact and for motion detector (PIR)
PIR	10	Digital input for motion detector (PIR)
24 V DC Out	11	Supply voltage for motion detector (PIR) Load: 100 mA max.

Communication interface	Terminal no.	
Zone Modbus Out	RJ12 socket	Connection to the following zone module

Display elements

Each zone module includes a two-digit 7-segment display (Fig. 6 /7). The 7-segment display indicates the status. The table below shows the symbols.

Segments

Display	Description
1-	Zone module in section 1 (zone master 1)
2-	Zone module in section 2 (zone master 2)
3-	Zone module in section 3 (zone master 3)
4-	Zone module in section 4 (zone master 4)
5-	Zone module in section 5 (zone master 5)
9-	No area number has been assigned by the zone master

Zone module address

Display	Description
01	Current zone module address as shown on the zone master (areas 1 – 25).
99	Current zone number (address) has not been received from the zone master

Sensor

Display	Description
°C	The temperature sensor (supply air, extract air or room air temperature) has been correctly connected
CO	The VOC or CO ₂ sensor (extract air or room air) has been correctly connected
°H	The humidity sensor (extract air or room air) has been correctly connected
LI	2 temperature sensors (supply air, extract air or room air temperature) have been connected
SC	Sensor short circuit

Room control panel

Display	Description
RP	Room control panel X-AIR-CP-2T has been connected

Software update

Display	Description
SU	Software update in progress Important: Do not interrupt the supply voltage!

2.2.2.1 Zone module X-AIR-ZMO-MP

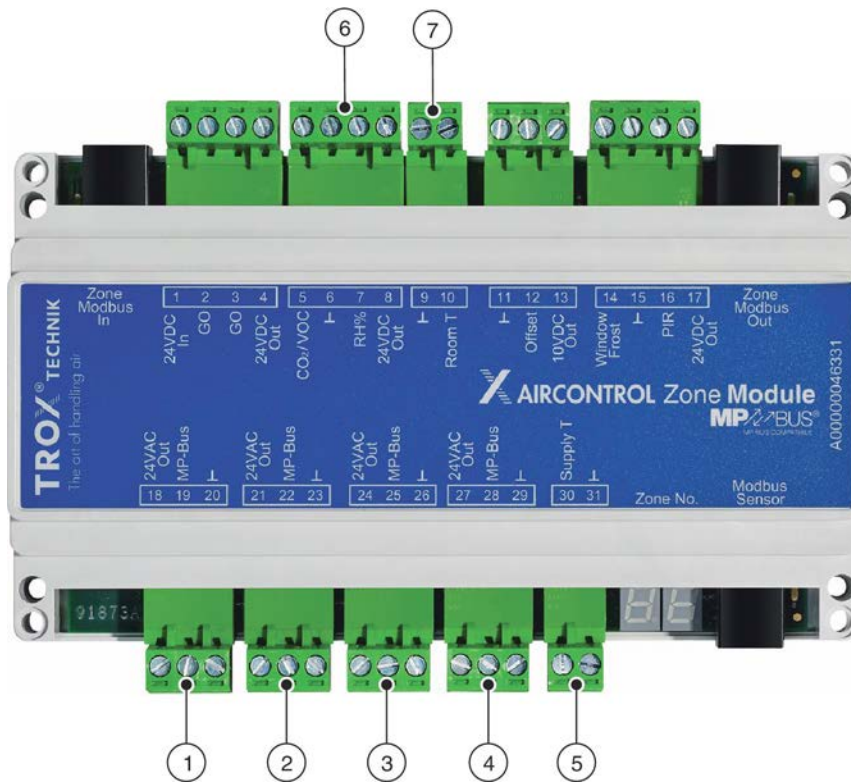

Fig. 7: Zone module X-AIR-ZMO-MP

- | | |
|--|---|
| <ul style="list-style-type: none"> 1 MP bus output A 2 MP bus output B 3 MP bus output C 4 MP bus output D | <ul style="list-style-type: none"> 5 Analogue input for supply air temperature sensor 6 Analogue inputs for CO₂/VOC and humidity 7 Analogue input for room temperature sensor |
|--|---|

Connections

MP bus output A	Terminal no.	
24 V AC Out	18	Supply voltage for volume flow controller (6 VA max.)
MP bus	19	MP bus output A for volume flow controller
⊥	20	GND for volume flow controller

MP bus output B	Terminal no.	
24 V AC Out	21	Supply voltage for volume flow controller (6 VA max.)
MP bus	22	MP bus output B for volume flow controller
⊥	23	GND for volume flow controller

MP bus output C	Terminal no.	
24 V AC Out	24	Supply voltage for volume flow controller (6 VA max.)
MP bus	25	MP bus output C for volume flow controller
⊥	26	GND for volume flow controller

MP bus output D	Terminal no.	
24 V AC Out	27	Supply voltage for volume flow controller (6 VA max.)
MP bus	28	MP bus output D for volume flow controller
⊥	29	GND for volume flow controller

Analogue input	Terminal no.	
Supply T	30	Analogue input for supply air temperature sensor (PT1000)
⊥	31	GND for analogue supply air temperature sensor (PT1000)

Analogue input	Terminal no.	
CO ₂ /VOC	5	Analogue input for CO ₂ /VOC sensor (0 to 10 V = 0 to 2000 ppm)
⊥	6	GND for CO ₂ /VOC and humidity sensors
rH%	7	Analogue input for humidity sensor (0 to 10 V = 0 to 100%)
24 V DC Out	8	Supply voltage for CO ₂ /VOC sensor (250 mA max.)
⊥	9	GND for room temperature sensor (PT1000)
Room T	10	Analogue input for room temperature sensor (PT1000)

Technical data

Dimensions	
Width	156 mm
Height	110 mm
Depth	45 mm
Weight	270 g

Electrical data	
Supply voltage	24 V AC \pm 10%
Power consumption (module)	\leq 3.5 VA (without any external sensors or actuators)

Network properties	
Modbus RTU (RS-485) outputs for actuating elements (Communication parameters)	3 x RJ12 plug (6P6C) Baud rate: 38.4 kBaud 1-8-N-2 (start bits, data bit, parity, stop bits)
Length of cable to modules	Cable type AWG26/6C 100 m max.
Length of cable to master	Cable type AWG26/6C 100 m max.
Cable length (actuating element/sensor/room control panel)	30 m max.
MP-Bus outputs for actuating elements (max. power rating)	4 x 6 VA max. (in total: 24 VA max.)

Inputs/outputs	
Digital inputs	2 x pull-up with ground contact
Sensor inputs	2 x for PT1000 1 x CO ₂ (0 – 10 V = 0 – 2000 ppm) 1 x rh% (0 – 10 V = 0 – 100%)
External temperature shift	1 x 0 – 10 V for \pm 5 K max.
Cable diameter	1.5 mm ² max.

Ambient conditions	
Acceptable relative humidity (rh)	10 – 90% (no condensation)
Max. temperature – operation	-20 to +50 °C
Max. temperature – storage	-30 to +70 °C
Protection level	IP 20 (EN 60529)

2.2.2.2 Zone module X-AIR-ZMO-MOD

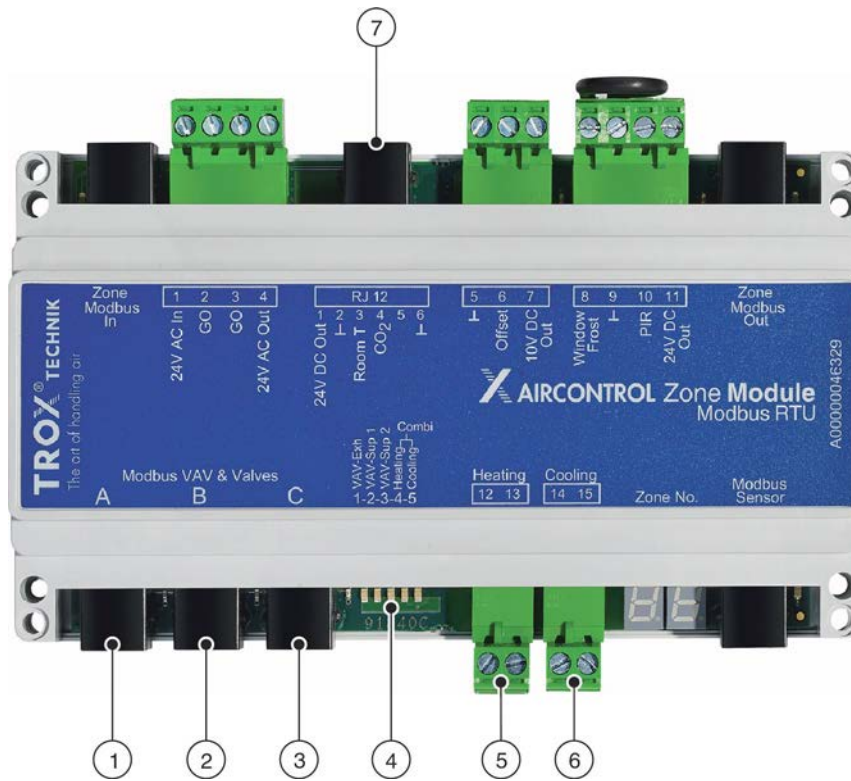

Fig. 8: Zone module X-AIR-ZMO-MOD

- | | |
|---|---|
| <ul style="list-style-type: none"> 1 Modbus output A 2 Modbus output B 3 Modbus output C 4 Status LEDs for actuating elements | <ul style="list-style-type: none"> 5 Digital output – heating 6 Digital output – cooling 7 Analogue inputs for CO₂ and room temperature sensor (PT1000) |
|---|---|

Connections

MP bus outputs	Terminal no.	
Modbus VAV & Valves	RJ12 socket	Modbus output A (max. 6 W)
		Modbus output B (max. 6 W)
		Modbus output C (max. 6 W)

Status LEDs for actuating elements	Terminal no.	
VAV-Exh	1	Extract air volume flow controller – output
VAV-SUP 1	2	Supply air volume flow controller – output 1
VAV-SUP 2	3	Supply air volume flow controller – output 2
Heating (Combi)	4	Digital output – heating
Cooling (Combi)	5	Digital output – cooling

Digital outputs	Terminal no.	
Heating	12	Digital output – heating
	13	
Cooling	14	Digital output – cooling
	15	

Analogue inputs (RJ12)	Pin no.	
24 V DC Out	1	Supply voltage for CO ₂ /VOC sensor (250 mA max.)
⊥	2	GND for CO ₂ /VOC sensor
Room T	3	Analogue input for room temperature sensor ¹ (PT1000)
CO ₂	4	Analogue input for CO ₂ /VOC sensor (0 to 10 V = 0 to 2000 ppm)
–	5	Not used
⊥	6	GND for room temperature sensor (PT1000)

1) If you connect an extract air sensor to the 'Modbus Sensor' input, the input for the room temperature will then be used for the supply air temperature.

Technical data

Dimensions and weight	
Width	156 mm
Height	110 mm
Depth	45 mm
Weight	270 g

Electrical data	
Supply voltage	24 V AC ±10%
Power consumption (module)	≤ 2 VA (without any external sensors or actuators)

Network	
Modbus communication	3 x RJ12 plug (6P/6C) RS-485, 38.4 kBaud
Length of cable to modules	Cable type: Telephone ribbon cable 6-core with RJ12 plugs (6P/6C) 100 m max.

Network	
Length of cable to master	Cable type: Telephone ribbon cable 6-core with RJ12 plugs (6P/6C) 100 m max.
Cable length (control element/sensor/room control panel)	30 m max.
Modbus RTU outputs for actuating elements (max. power rating)	3 x 6 VA max. (in total: 18 VA max.)

Inputs/outputs	
Digital inputs	2 x pull-up with ground contact
Digital outputs	2 x max. 5 A/230 V (Heating/Cooling)
Sensor inputs	1 x for PT1000 1 x CO ₂ (0 – 10 V = 0 – 2000 ppm)
External temperature shift	1 x 0 – 10 V for ± 5 K max.
Cable diameter	1.5 mm ² max.

Ambient conditions	
Acceptable relative humidity (rh)	10 – 90 % (no condensation)
Max. temperature – operation	-20 to +50 °C
Max. temperature – storage	-30 to +70 °C
Protection level	IP 20 (EN 60529)

2.2.2.3 Zone module X-AIR-ZMO-ANA

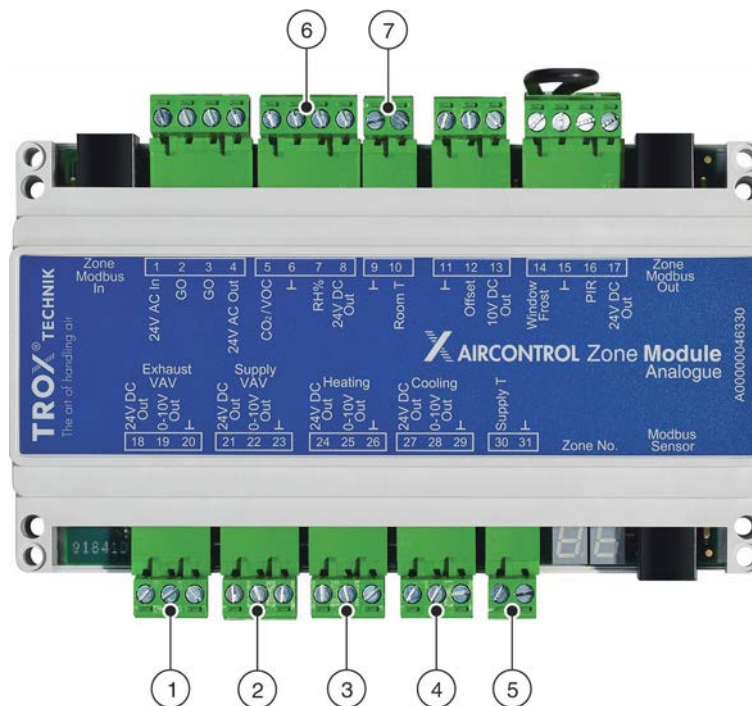

Fig. 9: Zone module X-AIR-ZMO-ANA

- | | |
|---|---|
| 1 Extract air volume flow controller – output | 5 Analogue input for supply air temperature sensor |
| 2 Supply air volume flow controller – output | 6 Analogue inputs for CO ₂ /VOC and humidity sensors |
| 3 Control element for heating – output | 7 Analogue input for room temperature sensor |
| 4 Control element for cooling – output | |

Connections

Extract air volume flow controller – output	Terminal no.	
Exhaust VAV 24 V DC Out	18	Extract air volume flow controller – output (6 VA max.)
0 – 10 V Out	19	Output signal
⊥	20	GND for volume flow controller

Supply air volume flow controller – output	Terminal no.	
Supply VAV 24 V DC Out	21	Supply air volume flow controller – output (6 VA max.)
0 – 10 V Out	22	Output signal
⊥	23	GND for volume flow controller

Control element for heating – output	Terminal no.	
Heating 24 V DC Out	24	Control element for heating – output (6 VA max.)
0 – 10 V Out	25	Output signal
⊥	26	GND for control element – heating

Control element for cooling – output	Terminal no.	
Cooling 24 V DC Out	27	Control element for cooling – output (6 VA max.)
0 – 10 V Out	28	Output signal
⊥	29	GND for control element – cooling

Temperature sensor	Terminal no.	
Supply T	30	Analogue input for supply air temperature sensor (PT1000)
⊥	31	GND for analogue supply air temperature sensor (PT1000)

Analogue input	Terminal no.	
CO ₂ /VOC	5	Analogue input for CO ₂ /VOC sensor (0 to 10 V = 0 to 2000 ppm)
⊥	6	GND for CO ₂ /VOC and humidity sensors
rh%	7	Analogue input for humidity sensor (0 to 10 V = 0 to 100%)
24 V DC Out	8	Supply voltage for CO ₂ /VOC sensor (250 mA max.)

Analogue input	Terminal no.	
⊥	9	GND for room temperature sensor (PT1000)
Room T	10	Input for room temperature sensor (PT1000)

Technical data

Dimensions and weight	
Width	156 mm
Height	110 mm
Depth	45 mm
Weight	270 g

Electrical data	
Supply voltage	24 V AC \pm 10%
Power consumption (module)	\leq 2.3 VA (without any external sensors or actuators)

Network	
Modbus communication	3 x RJ12 plug (6P/6C) RS-485, 38.4 kBaud
Length of cable to modules	Cable type: Telephone ribbon cable 6-core with RJ12 plugs (6P/6C) 100 m max.
Length of cable to master	Cable type: Telephone ribbon cable 6-core with RJ12 plugs (6P/6C) 100 m max.
Cable length (control element/sensor/room control panel)	30 m max.

Inputs/outputs	
Digital inputs	2 x pull-up with ground contact
Analogue outputs (VAV)	4 x 0 – 10 V (< 50 mA)
Cable cross section	1.5 mm ² max.

Ambient conditions	
Acceptable relative humidity (rh)	10 – 90 % (no condensation)
Max. temperature – operation	-20 to +50 °C
Max. temperature – storage	-30 to +70 °C
Protection level	IP 20 (EN 60529)

2.2.2.4 Zone module X-AIR-ZMO-COVER



Fig. 10: X-AIRCONTROL Zone module cover

Technical data

Dimensions and weight	
Width	170 mm
Length	170 mm
Height	41 mm
Casing	ABS plastic, RAL 9010 (white)
Installation	Can be plugged onto zone modules

2.2.3 Room control panel X-AIR-CP-2T



Fig. 11: Control panel with 2" touch display for X-AIRCONTROL

Connections

RJ12 socket	Description	Sensor	Duct (CH)	Connection
1	+24VDC	CO2/VOC	CH1	+24 VDC out ¹
2	GND			0 – 10 V in (0 – 10 V = 0 – 2000 ppm)
3	Bus B			GND
4	Bus A	Humidity	CH2	+24 VDC out ¹
5	+24VDC			0-10 V in (0 – 10 V = 0 – 100%)
6	GND			GND

1) In total 200 mA max. for CH1 and CH2

Technical data

Dimensions	
Height	82 mm
Width	82 mm
Depth	41 mm
Installation depth	22 mm

Electrical data	
Supply voltage	24 V DC ± 10%
Power consumption	775 mW (without any external sensors)
Power consumption in standby mode	500 mW

Terminal connection	
Connections	Modbus: RJ12 6P6C or 4 screw terminals Sensor: 6 screw terminals
Cable cross section	1.0 mm ² max.
Cable length	30 m max.

Ambient conditions	
Acceptable relative humidity (rh)	0 – 95% (no condensation)
Max. temperature – operation	-10 to +40 °C

Ambient conditions

Max. temperature – storage	-30 to +70 °C
Protection level	IP 21 (EN 60529)

2.2.4 Room control panel X-AIR-CP-TS

Fig. 12: Control panel with setpoint value adjuster and room temperature sensor for X-AIRCONTROL

Connections**Terminal connections**

1	+ PT-1000
2	- PT-1000
3	GND
4	0 – 10 V out
5	10 V DC

Technical data**Dimensions and weight**

Height	84 mm
Width	84 mm
Depth	27 mm

Electrical data

Supply voltage	10 V DC
Potentiometer (IN/OUT)	10 kohms (10 V DC)

Terminal connection

Connections	5 screw terminals
Cable cross section	1.5 mm ² max.

Ambient conditions	
Acceptable relative humidity (rh)	0 – 95% (no condensation)
Max. temperature – operation	-10 to +50 °C
Max. temperature – storage	-20 to +60 °C
Protection level	IP 30 (EN 60529)

2.2.5 Sensors

2.2.5.1 X-SENS-TEMP-RH-EXH



Fig. 13: Combined extract air temperature and humidity sensor for X-AIRCONTROL

Technical data

Dimensions and weight	
Length without connecting cable	300 mm
Diameter	12 mm
Installation depth	50 – 250 mm
Weight	250 g

Electrical data	
Supply voltage	24 V DC \pm 25%
Power consumption	220 mW max.
Measuring range – humidity	0 – 100% rh (no condensation)
Absolute error	< 2% rh (10% – 90% rh) < 5% rh (0% – 10% rh/90% – 100% rh)
Long term drift - humidity	< 0.5% rh per year

Electrical data

Measuring range – temperature	-40 to 120 °C
Absolute error	< 0.25 °C (15 to 40 °C)

Connection

Plug-in connecting cable	RJ12 6P6C, 7000 mm long
--------------------------	-------------------------

Ambient conditions

Max. temperature – operation	-20 to 50 °C (% rh 0 to +50 °C)
Max. temperature – storage	-40 to 80 °C
Protection level, duct interior	IP 32 (EN 60529)
Protection level, duct exterior	IP 54 (EN 60529)

2.2.5.2 X-SENS-TEMP-EXH

Fig. 14: Extract air temperature sensor for X-AIRCONTROL

Technical data**Dimensions and weight**

Length without connecting cable	300 mm
Diameter	12 mm
Installation depth	50 – 250 mm
Weight	250 g

Electrical data

Supply voltage	24 V DC \pm 25%
Power consumption	170 mW max.

Electrical data	
Absolute error	< 0.5 °C (-10 to 85 °C)
Measuring range – temperature	-40 – 85 °C

Connection	
Plug-in connecting cable	RJ12 6P6C, 7000 mm long

Ambient conditions	
Max. temperature – operation	-20 to +50 °C (% rh 0 to +50 °C)
Max. temperature – storage	-55 to +85 °C
Protection level, duct interior	IP 32 (EN 60529)
Protection level, duct exterior	IP 54 (EN 60529)

2.2.5.3 X-SENS-VOC



Fig. 15: VOC duct sensor for X-AIRCONTROL

Technical data

Dimensions and weight	
Length without connecting cable	160 mm
Diameter	19 mm
Installation depth	65 – 105 mm
Weight	175 g

Electrical data	
Supply voltage	24 V DC ± 25%
Power consumption	460 mW max.
Start-up time	15 min
Response time	< 5 min
Measuring range CO ₂ equivalent	450 – 2000 ppm (no condensation)
Absolute error	< 150 ppm
Airflow velocity	> 0 m/s

Connection	
Plug-in connecting cable	RJ12 6P6C, 7000 mm long

Ambient conditions	
Relative humidity	5 – 95% rh (no condensation)
Max. temperature – operation	0 to +50 °C
Max. temperature – storage	-25 to +50 °C
Protection level, duct interior	IP 32 (EN 60529)
Protection level, duct exterior	IP 54 (EN 60529)

2.2.5.4 X-SENS-SPLITTER



Fig. 16: Splitter for the 'Modbus sensor' output in X-AIRCONTROL

Technical data

Dimensions and weight	
Width	46 mm
Length	78 mm
Height	45 mm
Weight	60 g

Connections	
Spring clamp terminal	8 x 1.5 mm ²
RJ12 connection	4 x RJ12 socket

Ambient conditions	
Max. temperature – operation	0 to +50 °C
Max. temperature – storage	-25 to +50 °C
Protection level	IP 20 (EN 60529)

2.2.5.5 X-SENS-TEMP-PT1000



Fig. 17: PT1000 temperature sensor for X-AIRCONTROL

Technical data

Dimensions and weight	
Length without connecting cable	126 mm
Diameter	12 mm
Installation depth	50 – 115 mm
Weight	250 g

Connection

Connecting cable, open end	4000 mm long
----------------------------	--------------

Measured values

Measuring range – temperature	-40 °C – +85 °C
Absolute error	< 0.5 °C (15 to 40 °C) < 0.725 °C (-40 to 85 °C)
Resistance	0 °C = 1000 ohms
Measuring element	PT1000

Ambient conditions

Max. temperature – operation	-40 to +100 °C
Max. temperature – storage	-40 to +100 °C
Protection level	IP 32 (EN 60529)

2.2.5.6 X-SENS-CO2-RH

Fig. 18: Room CO₂ and humidity sensor for X-AIRCONTROL

Technical data**Electrical data**

Supply voltage (from the X-AIRCONTROL zone module)	24 V AC/DC
Power consumption	2 W max. for 20 ms (every 3 seconds) / 1 W max. for the remaining time
CO ₂ output, analogue	0 – 10 V
CO ₂ output, switch contact	24 V DC/50 mA
CO ₂ sensor	Optical NDIR CO ₂ sensor
Relative humidity output, analogue	0 – 10 V DC
Relative humidity output, switch contact	24 V DC/50 mA

Dimensions and weight	
Width	105 mm
Height	80 mm
Depth	23.5 mm
Casing	ABS plastic, RAL 9010 (white)

Measured values	
CO ₂ measuring range	0 – 2000 ppm
Humidity measuring range	0 – 100 %
Resolution	1 ppm
Accuracy	±30 ppm 20 – 80% rh ±3%

Ambient conditions	
Max. temperature – operation	0 to +50 °C
Protection level	IP 30

2.2.5.7 X-SENS-DEWP



Fig. 19: Dew point sensor for X-AIRCONTROL

Technical data

Electrical data	
Supply voltage (from the X-AIRCONTROL zone module)	24 V AC/DC ±20%
Power consumption	1 VA max.

Electrical data	
Relay output	30 V AC/DC max. 1 A AC/0.5 A DC max.
Switching point	92 + 4% rh at 25 °C
Hysteresis, fixed	Approx. 5% rh
Response in still air	Approx. 3 min
Connection	Screw terminals, 1.5 mm ² max.

Dimensions of processing unit	
Width	73 mm
Height	60 mm
Depth	37 mm
Casing	Thermoplastic, pure white, flame retardant

Dimensions of sensor head	
Width	36 mm
Height	62 mm
Depth	11 mm

Ambient conditions	
Max. temperature – operation	-5 to 50 °C
Relative humidity	5 to 95% rh
Protection level	IP 40
IEC protection class	III

2.2.5.8 X-SENS-PIR-SM



Fig. 20: Wall-mounted motion detector for X-AIRCONTROL

Technical data

Power supply	
Supply voltage (from the X-AIRCONTROL zone module)	12 – 48 V AC/DC +10%
Power consumption	0.4 W at 24 V DC
Operational range	180°
Detection range	10 m (Ø tangential movement) (people walking by) 4 m (Ø radial) (people sitting)

Dimensions	
Width	88 mm
Height	88 mm
Depth	64 mm
Casing	UV stabilised polycarbonate NCS-S-0500N matt
Installation	Junction boxes (for flush mounting) Diameter 60 mm
Installation height (recommended)	1.1 to 2.2 m (4 m max.)
Spring clamp terminal	8 x 1.5 mm ²

Outputs	
Switch output R1 (Brightness: 5 to 2000 lx) (Run down time: 15 s to 30 min)	24 V/0.1 A (volt-free)
Switch output R2 (Motion detector run down time: 5 to 120 min)	24 V/0.1 A (volt-free)

Ambient conditions	
Max. temperature – operation	-25 to +55 °C
Relative humidity	10 – 95% rh (no condensation)
Protection level	IP 20
IEC protection class	II

2.2.5.9 X-SENS-PIR-FM



Fig. 21: Ceiling-mounted motion detector for X-AIRCONTROL

Technical data

Electrical data	
Supply voltage (from the X-AIRCONTROL zone module)	24 V AC/DC \pm 10%
Power consumption	0.4 W
Operational range	360°
Detection range	8 m (\varnothing tangential movement) (people walking by) 4 m (\varnothing radial) (people sitting)

Dimensions	
Dimensions (\varnothing , height)	98 mm x 48 mm
Installation height (recommended)	2.5 to 3 m (10 m max.)
Spring clamp terminal	8 x 1.5 mm ²
Installation	For surface mounting

Outputs	
Switch output R1 (Brightness: 5 to 2000 lx) (Run down time: 15 s to 30 min)	24 V/0.1 A (volt-free)
Switch output R2 (Motion detector run down time: 5 to 120 min)	24 V/0.1 A (volt-free)

Ambient conditions	
Max. temperature – operation	-25 to +55 °C
Relative humidity	10 – 95% rh (no condensation)
Protection level	IP 20
IEC protection class	II

3 Setting up system components on the webserver

3.1 Configuring the network access

Personnel:

- Network administrator

The 'TCP/IP BMS' connection on the zone master requires an IP address; you can enter a static IP address or have the system assign a dynamic (DHCP) IP address.

Default (factory) network settings on the zone master:

- Static IP address: 192.168.0.201
- Subnet mask: 255.255.255.0
- Gateway: 192.168.0.1
- DNS: 192.168.0.1
- Alternative DNS: 0.0.0.0

If you connect the zone master to a personal computer, using a network cable, you need to set the static IP address on the zone master.

Having the IP address assigned dynamically (DHCP) is recommended only if you can verify the IP address that the zone master assigns.

If you don't know the IP address, use the 'IP-Config' software to reset the IP address.

1. ▶ Connect the network cable to the TCP/IP interface of the zone master.
2. ▶ Connect the other end of the network cable to the TCP/IP interface of a notebook or personal computer.
3. ▶ Go to the Control Panel of your notebook or personal computer and adjust the network settings so that the computer is in the same network as the zone master.
4. ▶ Go to the address field of an Internet browser (e.g. Google Chrome, Internet Explorer or Mozilla Firefox) and enter the IP address of the zone master (192.168.0.201).

⇒ The 'welcome screen' (Fig. 22) displays.



Fig. 22: X-AIRCONTROL

5. ▶ Click on the welcome screen (Fig. 22).
⇒ The Start screen displays (Fig. 23).



Fig. 23: Home screen

3.2 Start screen functions

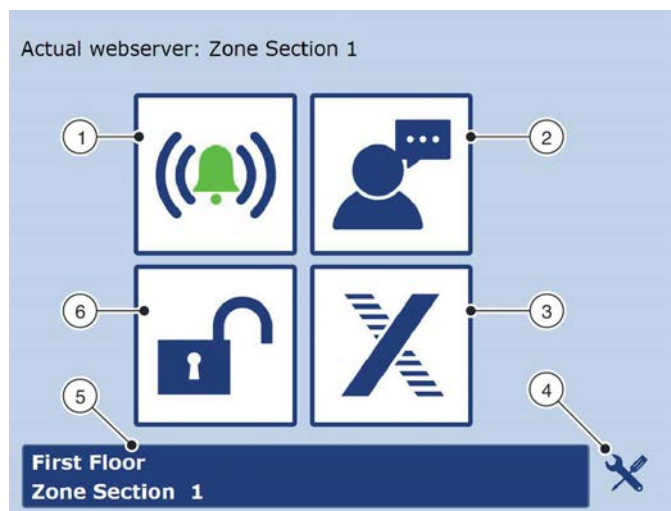

Fig. 24: Start screen

- 1 Display alarms
- 2 Change display language
- 3 Display TROX GmbH website
- 4 Display the service screen
- 5 Zone overview
- 6 Log in to the webserver

Once you have logged in to the webserver (↗ 3.4 'Logging in to the webserver' on page 48), the Start screen displays (Fig. 24).

On the Start screen you can select the following functions by clicking the respective button (Fig. 24 /1 – 6).

- Display alarms
(↗ 4.6.5 'Displaying alarms' on page 87)
- Change display language
(↗ 3.3 'Selecting a language' on page 47)
- Display TROX GmbH website
- Displaying the service screen
(↗ 3.6 'Displaying the service screen' on page 49)
- Zone overview
(↗ 3.7 'Zone overview' on page 50)
- Log in to the webserver
(↗ 3.4 'Logging in to the webserver' on page 48)

The table ↗ 'Menu structure' on page 47 shows the menu structure of the webserver. The menu structure shows you where to find each function.

Menu structure

Start screen	Submenu 1	Submenu 2	Submenu 3
Displaying alarms	↳ 4.6.5 'Displaying alarms' on page 87	–	–
↳ 3.3 'Selecting a language' on page 47	–	–	–
↳ 3.4 'Logging in to the webserver' on page 48	–	–	–
Info	–	–	–
Zone master settings	↳ 3.7 'Zone overview' on page 50	↳ 3.8.9 'Setting zone values' on page 58	–
↳ 3.6 'Displaying the service screen' on page 49	↳ 3.8.1 'Activating the device detection mode' on page 51	↳ 3.8.3 'Setting the volume flow rate' on page 54	↳ 3.8.4 'Checking the volume flow rate' on page 54
		↳ 3.8.5 'Setting up a supply branch' on page 55	
		↳ 3.8.6 'Setting up an extract branch' on page 56	
	↳ 3.8.10 'Configuring the zone master' on page 65	–	–
	AHU	–	–
	BACnet	–	–
	↳ 3.8.11 'Summer and winter compensation' on page 71	–	–
	↳ 3.5 'Setting date and time on the webserver' on page 49	–	–
	↳ 3.8.12 'Network connection settings' on page 71	–	–
	Display TROX GmbH website	–	–

3.3 Selecting a language

The 'Language' (Fig. 25) screen allows you to select one of the following languages:

- Danish
- English
- German
- Swedish
- Norwegian
- Spanish
- French

- Polish
- Russian

1. ▶ On the 'Start' screen (↳ 3.2 'Start screen functions' on page 46), click on the button for 'Language'.
 - ⇒ The 'Language' screen (Fig. 25) displays.



Fig. 25: Selecting a language

2. ▶ Select a language.
 - ⇒ The display language for the webserver is set accordingly.

3.4 Logging in to the webserver

The configuration and setting of X-AIRCONTROL requires you to log in to the webserver with your password. The default password is 'Service'. Displaying system settings does not require you to log in with your password.

1. ▶ On the 'Start' screen (↪ 3.2 'Start screen functions' on page 46), click on the padlock symbol.
 - ⇒ The 'Login' screen (Fig. 26) displays.

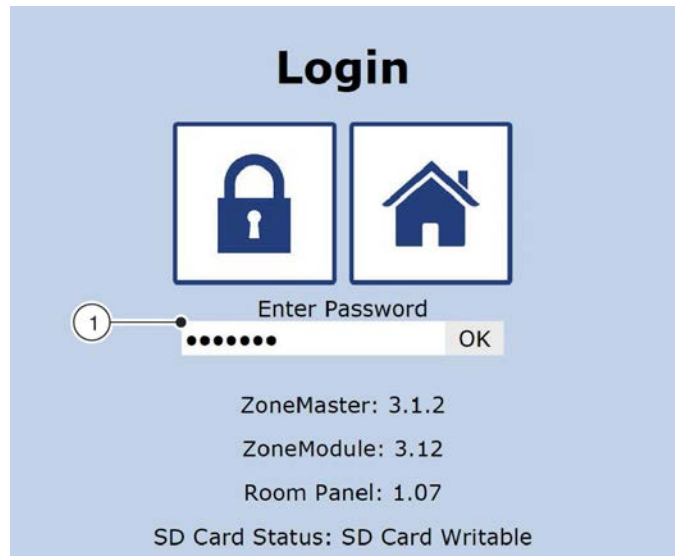

Fig. 26: Login

2. ▶ Enter the default password 'Service' into the entry field (Fig. 26 /1).
3. ▶ Confirm your entry with 'OK' or press the Enter key on your keyboard.

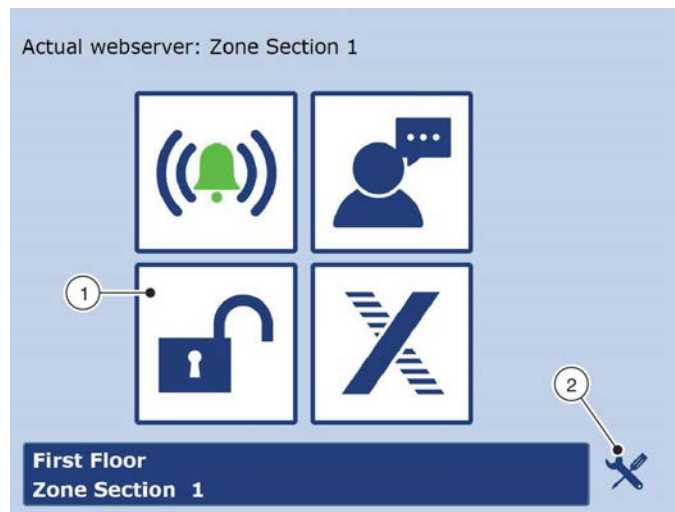

Fig. 27: You have been logged in

- ⇒ The Start screen shows an open padlock (Fig. 26 /1). You can now access the Service screen (Fig. 27 /2) for configuration and settings.

3.5 Setting date and time on the web-server

The 'Time and Date' screen (Fig. 28) allows you to set the current time and date manually or to have them set automatically. Automatic setting means that the time and date of the zone master are synchronised with the time and date of your notebook or personal computer.

1. ▶ Log in to the webserver (↗ 3.4 'Logging in to the webserver' on page 48).
2. ▶ On the Start screen (↗ 3.2 'Start screen functions' on page 46), click on the 'Tools' symbol.
 - ⇒ The Service screen displays.
3. ▶ Click on the clock symbol.
 - ⇒ The 'Time and Date' screen (Fig. 28) displays.

Fig. 28: Time and date

4. ▶ If you want to activate summer time (daylight saving time), check the appropriate box (Fig. 28 /4).

Setting date and time automatically

5. ▶ Click on 'PC time' (Fig. 28 /6).
6. ▶ Click on 'Save' (Fig. 28 /7).
 - ⇒ Date and time have been synchronised with the PC date and time.

Setting date and time manually

1. ▶ Enter the current year (Fig. 28 /1).
2. ▶ Select the current month (Fig. 28 /2) from the dropdown list.
3. ▶ Enter the current day (Fig. 28 /3).

4. ▶ Enter the current time (Fig. 28 /5).
5. ▶ Click on 'Save' (Fig. 28 /7).
 - ⇒ Date and time have been set.

3.6 Displaying the service screen

- ▶ On the 'Start' screen (↗ 3.2 'Start screen functions' on page 46), click on the Tools symbol.
 - ⇒ The Service screen (Fig. 29) displays.



Fig. 29: Service

From the 'Setup' screen the following functions are available when you click the respective button (Fig. 29 /1 – 9).

- Displaying zone setup (Fig. 29 /1) (↗ 3.8.1 'Activating the device detection mode' on page 51) (↗ 3.8.2 'Configuring actuators and sensors' on page 53)
- Configuring the zone master (Fig. 29 /2) (↗ 3.8.10 'Configuring the zone master' on page 65)
- Integrating X-AIRCONTROL with a central BMS using the KNX protocol. (The KNX protocol is not supported at this time) (Fig. 29 /3) (↗ 6 'Integrating X-AIRCONTROL with a central BMS' on page 90)

Zone overview

- Setting summer and winter compensation (Fig. 29 /4)
(↪ 3.8.11 'Summer and winter compensation' on page 71)
- Configuring zone master network settings (Fig. 29 /5)
- Connecting X-AIRCONTROL to an air handling unit using the Modbus RTU protocol (Fig. 29 /6)
(↪ 6 'Integrating X-AIRCONTROL with a central BMS' on page 90)
- Integrating X-AIRCONTROL with a central BMS using the BACnet protocol (Fig. 29 /7)
(↪ 6 'Integrating X-AIRCONTROL with a central BMS' on page 90)
- Setting date and time on the webserver (Fig. 29 /8)
(↪ 3.5 'Setting date and time on the webserver' on page 49)
- Displaying system information (Fig. 29 /9)
(↪ 3.2 'Start screen functions' on page 46)
- Displaying zone settings (Fig. 30 /4)
(↪ 3.8.9 'Setting zone values' on page 58)
- Displaying zone setup (Fig. 30 /3)
(↪ 3.8 'Configuring zone modules' on page 51)
- Finding zone modules (Fig. 30 /5)
(↪ 'Finding zone modules' on page 50)
- Displaying alarms (Fig. 30 /1)
(↪ 4.6.5 'Displaying alarms' on page 87)

Finding zone modules

The loudspeaker buttons (Fig. 30 /5) allow you to have zone modules emit a sound so that you can easily detect them.

- ▶ Click on the loudspeaker symbol (Fig. 30 /5) for a zone module.
 - ⇒ The zone module will emit a sound such that you can detect it.

3.7 Zone overview

- ▶ On the 'Start' screen (↪ 3.2 'Start screen functions' on page 46), click on the button for zone overview.
 - ⇒ The 'Zone Overview' screen (Fig. 30) displays.

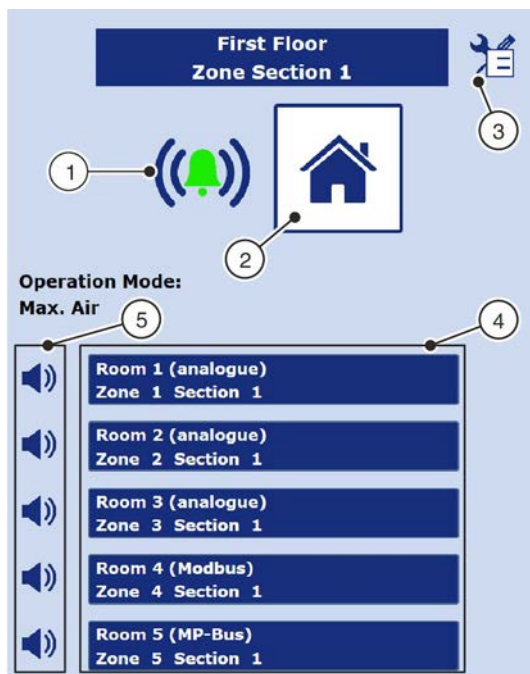

Fig. 30: Zone overview

From the 'Zone Overview' screen the following functions are available when you click on the respective button (Fig. 30 /1 – 5). The screen shows only zones whose zone modules have been detected by the zone master (Fig. 30 /4).

- Displaying the Start screen (Fig. 30 /2)

3.8 Configuring zone modules

3.8.1 Activating the device detection mode

The 'Zone Setup' screen (Fig. 31) allows you to automatically detect the sensors and actuators that are connected to zone modules. This automatic configuration also allows you to deactivate individual sensors or actuators while the system is in operation; no fault will be generated. You can adjust the components for each zone module when you carry out configuration manually (↪ 3.8.2 'Configuring actuators and sensors' on page 53).

If during manual or automatic zone setup either 'Modbus' or 'MP bus' is displayed after an actuator or a sensor, this means that a component on the bus has been detected. Components that have not been connected and that are hence not part of the bus system should be deactivated during commissioning as otherwise they may generate faults.

Automatic detection of connected components

	Module Detection	X-AIR-ZMO-ANA		X-AIR-ZMO-MP		X-AIR-ZMO-MOD	
		Autom.	Manually	Autom.	Manually	Autom.	Manually
Supply air volume flow controller	Fig. 33 /4		X	X		X	
Extract air volume flow controller	Fig. 33 /5		X	X		X	
Heating valve actuator	Fig. 33 /6		X	X			X
Cooling valve actuator	Fig. 33 /7		X	X			X
Window contact	Fig. 33 /8		X		X		X
Frost protection sensor	Fig. 33 /9		X		X		X
Motion detector (PIR sensor)	Fig. 33 /10		X		X		X
Room temperature sensor	Fig. 33 /11	X		X		X ¹	
Supply air temperature sensor	Fig. 33 /12	X			X		X ¹
Setpoint value adjuster	Fig. 33 /13		X		X		X
CO2/VOC sensor	Fig. 33 /14	X		X		X	X
Humidity sensor	Fig. 33 /15	X		X		X	

1) If the system detects a room temperature sensor on the 'Modbus sensor' connection, the PT1000 room temperature sensor connected to the RJ12 socket (Fig. 8 /7: terminal 3) becomes a supply air sensor.

- ▶ Log in to the webserver (↪ 3.4 'Logging in to the webserver' on page 48).
- ▶ On the Start screen (↪ 3.2 'Start screen functions' on page 46), click on the Tools symbol for a zone section.
 - ⇒ The Service screen displays.
- ▶ On the 'Service screen', click on 'Zone Setup'.
 - ⇒ The 'Zone Setup' screen displays.
- ▶ On the 'Zone Setup' screen, click on the Tools symbol.

⇒ Automatic actuator and sensor detection has been enabled (Fig. 31).



Fig. 31: Zone setup

When the automatic detection of actuators and sensors is complete, the screen is updated (Fig. 31) and shows the actuators and sensors connected to the zone modules. Automatic configuration does not allow you to make any adjustments manually.

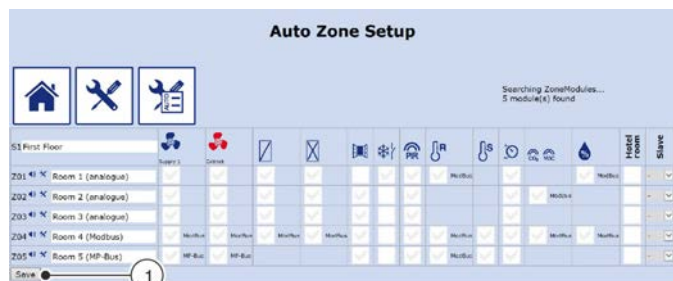

Fig. 32: Actuators and sensors

5. ▶ Click on 'Save' (Fig. 31 /1).

⇒ Actor and sensor data for the zone master has been saved.

3.8.2 Configuring actuators and sensors

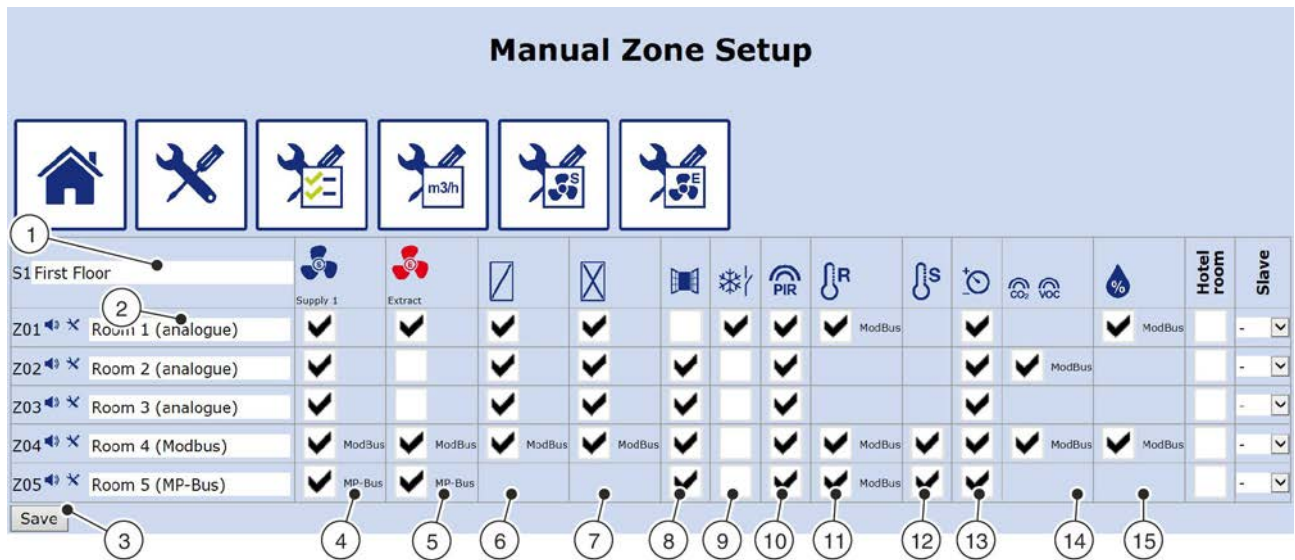

Fig. 33: Manual zone setup

- | | |
|-------------------------|-------------------------------------|
| 1 Section | 9 Frost protection sensor |
| 2 Zone | 10 Motion detector (PIR) |
| 3 Save | 11 Room air temperature |
| 4 Supply air flow rate | 12 Supply air temperature |
| 5 Extract air flow rate | 13 Analogue setpoint value adjuster |
| 6 Heating | 14 CO ₂ /VOC |
| 7 Cooling | 15 Humidity |
| 8 Window contact | |

The 'Zone Setup' screen (Fig. 33) allows you to configure the actuators and sensors that are connected to the zone modules. During operation the connected actuators and sensors are monitored such that hardware problems and connection errors will be detected.

The table [on page 51](#) shows the actuators and sensors that are automatically detected or which have to be activated or deactivated manually during commissioning.

- ▶ Log in to the webserver ([3.4 'Logging in to the webserver' on page 48](#)).

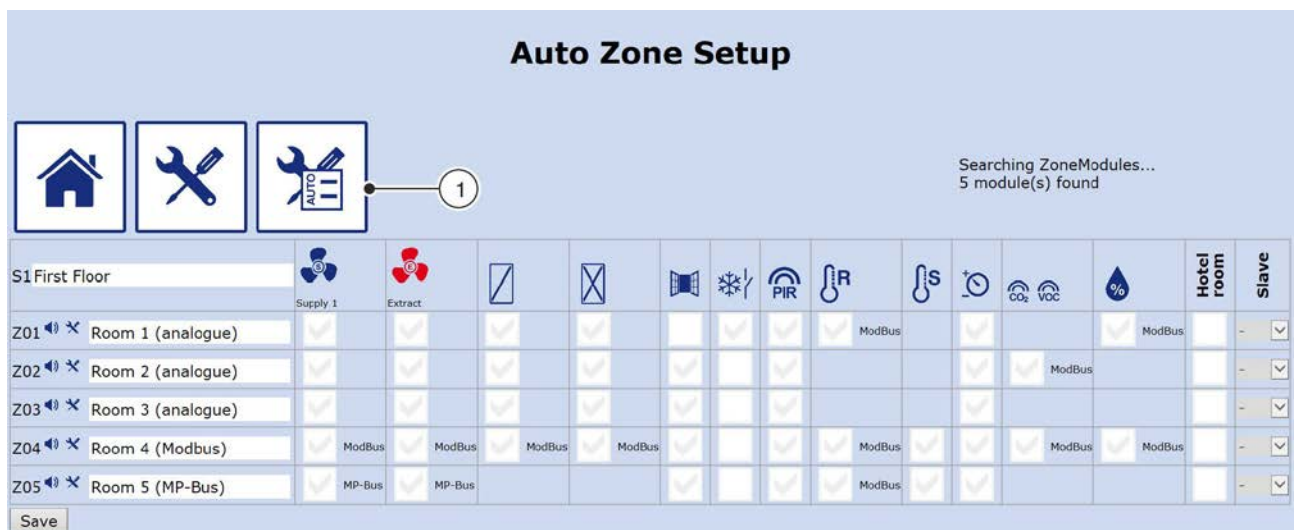

Fig. 34: Automatic zone setup

- ▶ To configure actuators and sensors manually, click the button in Fig. 34 /1.
 - ⇒ This activates manual configuration; you can now configure actuators and sensors for each zone module.

3. ▶ Activate or deactivate actuators and sensors (Fig. 33 /4 –15) for individual zone modules.
4. ▶ Enter a name for each zone module (Fig. 33 /2).
5. ▶ Enter a name for the zone master (section) (Fig. 33 /1).
6. ▶ Click on 'Save' (Fig. 33 /3).
 - ⇒ The configuration of each zone module has been saved.

3.8.3 Setting the volume flow rate

The 'Air Volume Setup' screen (Fig. 35) allows you to set supply air and extract air volume flow rates for analogue zone modules. You can also assign several zone modules to one extract air controller. If zone modules do not have individual, dedicated extract air controllers you can assign them to the extract air controllers of other zones.

1. ▶ Log in to the webserver (↪ 3.4 'Logging in to the webserver' on page 48).
2. ▶ Activate the device detection mode for the actuators and sensors connected to the zone modules (↪ 3.8.1 'Activating the device detection mode' on page 51).
3. ▶ Manually configure the actuators and sensors for each zone module (↪ 3.8.2 'Configuring actuators and sensors' on page 53).
4. ▶ On the 'Zone Setup' screen, click on the button for 'Volume Flow Rate Setup'.
 - ⇒ The 'Air Volumen Setup' screen (Fig. 35) displays.

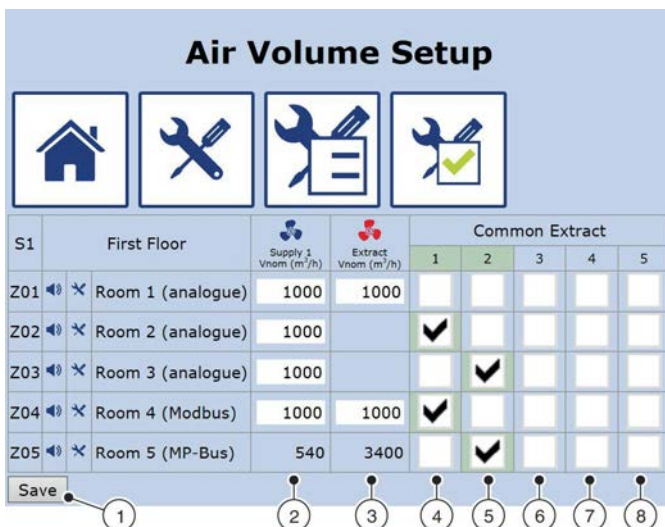

Fig. 35: Air volume setup (volume flow rate setup)

5. ▶ Enter the supply air and extract air flow rates into the entry fields (Fig. 35 /2+3).
6. ▶ Enter the extract air controllers to be shared by several zone modules into the appropriate columns (Fig. 35 /4 – 8).
7. ▶ Click on 'Save'.

⇒ The volume flow rates and the extract air controller assignment have been saved.

3.8.4 Checking the volume flow rate

The 'Air Volume Check' screen (Fig. 36) shows the volume flow rates for all supply air and extract air controllers for each zone. The fields marked green represent damper blade positions (Fig. 36 /4); use them as a reference for optimising the fan speed. The referenced fan is the one that is controlled by the controller with the highest volume flow rate. For more information on how to optimise the supply air and extract air branches see ↪ 3.8.5 'Setting up a supply branch' on page 55 and ↪ 3.8.6 'Setting up an extract branch' on page 56 .

The 'Air Volume Check' screen allows you to enable the preset minimum or maximum volume flow rate for a volume flow rate check.

The 'Air Volume Check' screen (Fig. 36) also allows you to adjust the volume flow controllers for initial commissioning.

1. ▶ Log in to the webserver (↪ 3.4 'Logging in to the webserver' on page 48).
2. ▶ Activate the device detection mode for the actuators and sensors connected to the zone modules (↪ 3.8.1 'Activating the device detection mode' on page 51).
3. ▶ Manually configure the actuators and sensors for each zone module (↪ 3.8.2 'Configuring actuators and sensors' on page 53).
4. ▶ On the 'Zone Setup' screen, click on 'Air Volume Check'.
 - ⇒ The 'Air Volume Check' screen (Fig. 36) displays.

Setting the minimum volume flow rate

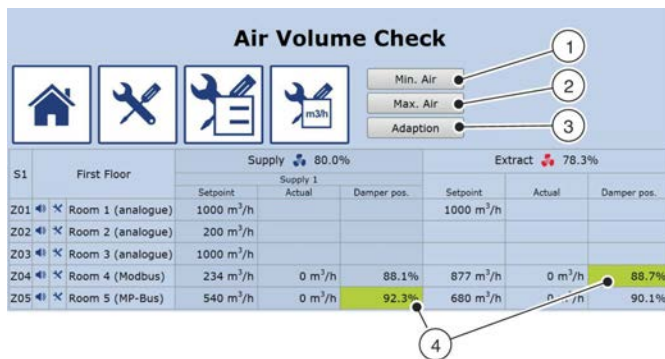

Fig. 36: Air volume check (volume flow rate check)

- 5. ▶ Click on 'Min. Air' (Fig. 36 /1).

This sets the minimum volume flow rate for the volume flow controller.

Setting the maximum volume flow rate

- 6. ▶ Click on 'Max. Air' (Fig. 36 /2).

This sets the maximum volume flow rate for the volume flow controller.

Capturing the entire volume flow rate range (from min. to max.)

- 7. ▶ Click on 'Adaption' (Fig. 36 /3).

⇒ You can manually activate the adjustment of all Modbus or MP bus volume flow controllers by clicking the 'Adaption' button. Adaption (i.e. an adjustment run) covers the entire adjustment range, i.e. the actuator will move from one end position to the other end position. After this procedure the actuator remains in the position indicated by the control signal.

3.8.5 Setting up a supply branch

The 'Supply Branch Setup' screen allows you to assign several zone modules to a supply branch. If you have assigned a supply branch to a zone module, the zone module is only used for the control of the selected supply branch. The 'Supply Branch Setup' screen also allows you to set the PI values for the selected supply branch.

The 'Supply Branch Setup' screen allows you to enable volume flow rate optimisation for individual zone modules. Volume flow rate control is set to 80% of the maximum output based on the required volume flow rate and with the largest opening angle (percentage) of the supply air damper.

- 1. ▶ Log in to the webserver (↪ 3.4 'Logging in to the webserver' on page 48).
- 2. ▶ Activate the automatic device detection mode (↪ 3.8.1 'Activating the device detection mode' on page 51).

- 3. ▶ Activate the manual adjustment of actors and sensors for the zone modules (↪ 3.8.2 'Configuring actuators and sensors' on page 53).

- 4. ▶ On the 'Zone Setup' screen, click 'Supply Branch Setup'.

⇒ The 'Supply Branch Setup' screen (Fig. 37) displays.

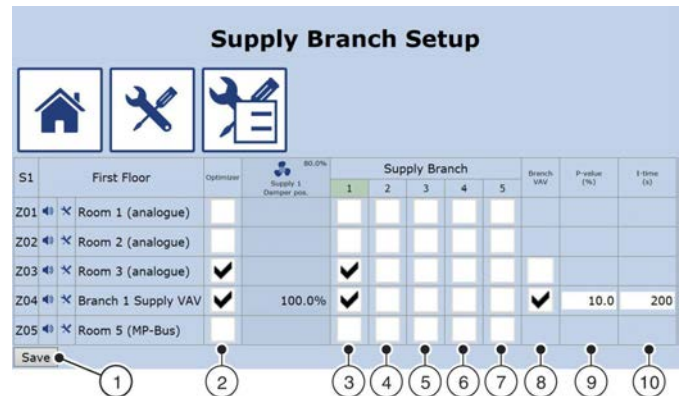

Fig. 37: Supply Branch Setup

- 5. ▶ Go to the individual columns (Fig. 37 /3 – 7) to assign a common supply branch to the zone modules.
- 6. ▶ If you want to enter PI values, select the corresponding 'Branch VAV' (i.e. volume flow controller for the branch) (Fig. 37 /8).
- 7. ▶ Enter P values as percentages (Fig. 37 /9).

PI control (called 'PI regulation' in the software)

The PI control values are factory set, and you should not change them yourself. Only the TROX Technical Service or specifically trained experts should change the PI control values. Structural conditions (building) have to be considered. The volume flow controller for the supply branch has to be set to 'open loop' with the Belimo PC tool.

- 8. ▶ Enter the integration time in seconds (Fig. 37 / 10).
 - 9. ▶ To optimise the supply branch for each zone module, check the appropriate boxes (Fig. 37).
 - 10. ▶ Click on 'Save' (Fig. 37 /1).
- ⇒ The supply branch settings have been saved.

3.8.6 Setting up an extract branch

The 'Extract Branch Setup' screen allows you to assign zone modules to an extract branch. If you have assigned an extract branch to a zone module, the zone module is only used for the control of the selected extract branch. The 'Extract Branch Setup' screen also allows you to set the PI values for the selected extract branch.

The 'Extract Branch Setup' screen allows you to enable volume flow rate optimisation for individual zone modules. Volume flow rate control will then be set to 80% of the maximum output based on the required volume flow rate and with the largest opening angle (percentage) of the extract air damper.

1. ▶ Log in to the webserver (↪ 3.4 'Logging in to the webserver' on page 48).
2. ▶ Activate the automatic device detection mode (↪ 3.8.1 'Activating the device detection mode' on page 51).
3. ▶ Activate the manual adjustment of actuators and sensors for the zone modules (↪ 3.8.2 'Configuring actuators and sensors' on page 53).
4. ▶ On the 'Zone Setup' screen, click 'Extract Branch Setup'.
 - ⇒ The 'Extract Branch Setup' screen (Fig. 38) displays.

PI control ('PI regulation')

The PI control values are factory set, and you should not change them yourself. Only the TROX Technical Service or specifically trained experts should change the PI control values. Structural conditions (building) have to be considered. The volume flow controller for the extract branch has to be set to 'open loop'; use the Belimo PC tool to do this.

8. ▶ Enter the integration time in seconds (Fig. 38 / 10).
9. ▶ To optimise the extract branch for each zone module, check the appropriate boxes (Fig. 38).
10. ▶ Click on 'Save' (Fig. 38 /1).
 - ⇒ The extract branch settings have been saved.

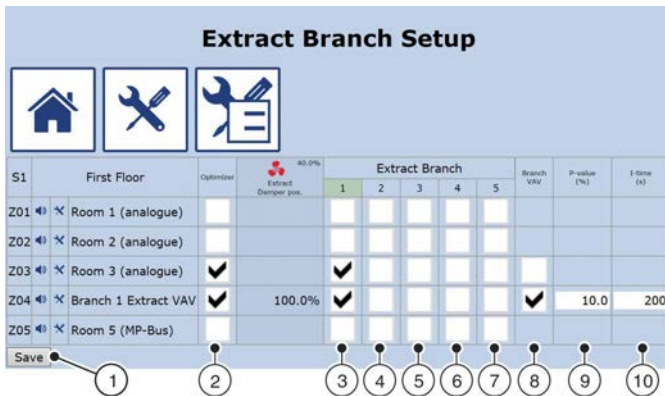

Fig. 38: Extract Branch Setup

5. ▶ Go to the individual columns (Fig. 38 /3 – 7) to assign a common extract branch to the zone modules.
6. ▶ If you want to enter PI values, select the corresponding 'Branch VAV' (i.e. volume flow controller for the branch) (Fig. 38 /8).
7. ▶ Enter P values as percentages (Fig. 38 /9).

3.8.7 Zone grouping

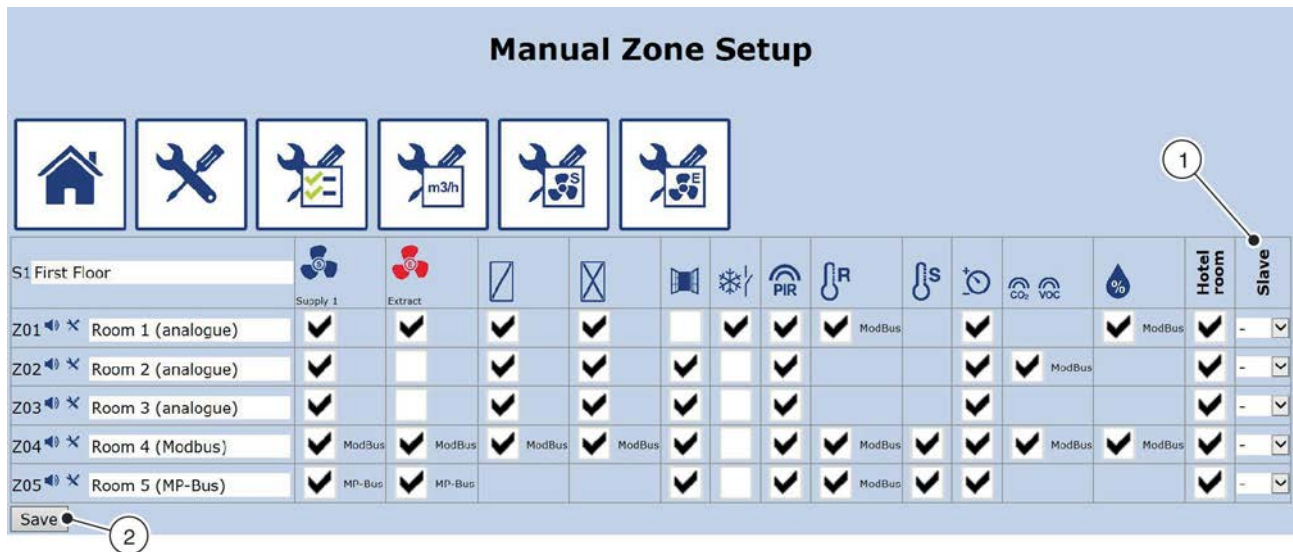

Fig. 39: Zone grouping

The grouping function (Fig. 39 /1) allows you to assign several zone modules to a group. Grouping is recommended if there are several zone modules installed in a larger section or room and if you want to control them simultaneously with one control panel. The 'Manual Zone Setup' screen allows you to select the leading zone module from a drop down list. Once you have defined the leading zone module, all actuators for all zone modules in the group act according to the leading zone module. Also, if you have defined a leading zone module, only the control panel for that module remains active; the control panels for the other zone modules are not active. All zone modules in a group are controlled with the control panel for the leading zone module.

1. ▶ Log in to the webserver (↗ 3.4 'Logging in to the webserver' on page 48).
2. ▶ Activate the automatic device detection mode (↗ 3.8.1 'Activating the device detection mode' on page 51).
3. ▶ Activate the manual adjustment of actors and sensors for the zone modules (↗ 3.8.2 'Configuring actuators and sensors' on page 53).
 - ⇒ The 'Zone Setup' screen (Fig. 39) displays.
4. ▶ Go to the drop down menu for a zone in the 'Slave' column (Fig. 39 /1) and select the leading zone module.
5. ▶ Click on 'Save' (Fig. 39 /2).
 - ⇒ Zone grouping is now complete, the groups have been saved.

3.8.8 Hotel mode

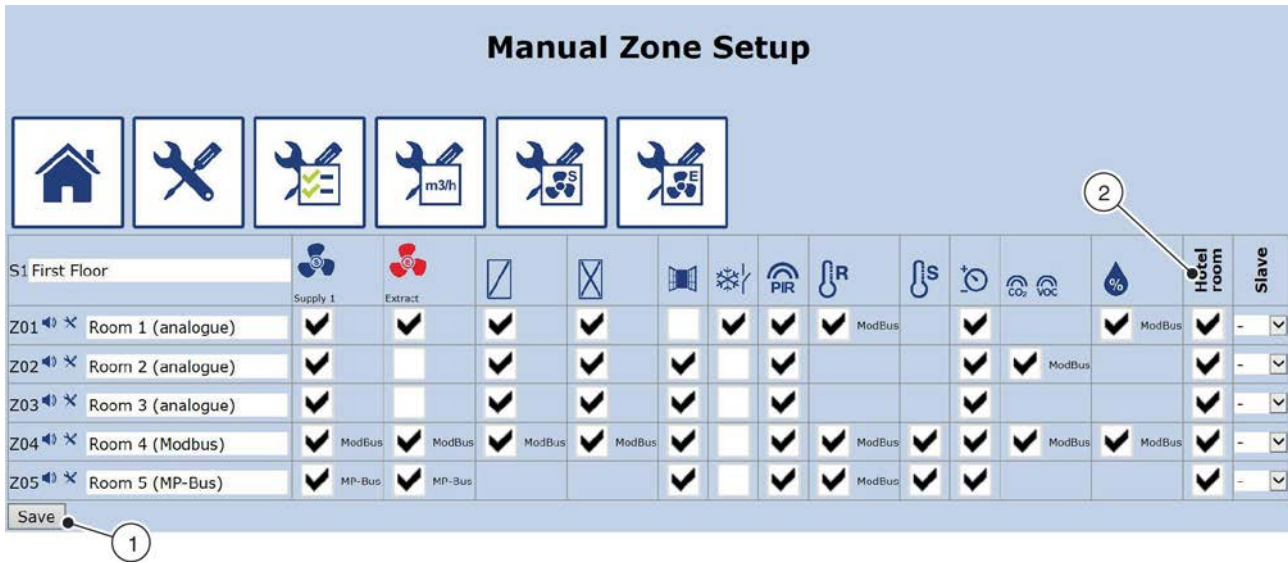

Fig. 40: Hotel mode

The 'Zone Setup' screen (Fig. 40) allows you to enable the hotel mode for individual zone modules. In hotel mode the temperature setpoint values for each guest room are reset every day to the temperature setpoint defined in the zone master. The reset time should also have been defined in the zone master. Once you have enabled the hotel mode for a zone module, the scheduling function on the room control panel is no longer active.

1. ▶ Log in to the webserver (↗ 3.4 'Logging in to the webserver' on page 48).
2. ▶ Activate the automatic device detection mode (↗ 3.8.1 'Activating the device detection mode' on page 51).
3. ▶ Activate the manual adjustment of actuators and sensors for the zone modules (↗ 3.8.2 'Configuring actuators and sensors' on page 53).
 - ⇒ The 'Zone Setup' screen (Fig. 40) displays.
4. ▶ If you want to activate the hotel mode for a zone module, check the appropriate box (Fig. 40 /2).
5. ▶ Click on 'Save' (Fig. 40 /1).
 - ⇒ The settings for hotel mode have been saved.

3.8.9 Setting zone values

The screenshot shows the webserver interface for setting zone values. The title bar indicates 'Room 4 (Modbus) Zone 4 Section 1'. The interface is divided into sections for different components, each with a set of parameters and controls. The parameters are listed in a table-like format with 'Actual' and 'Setpoint' values, and some have 'Override' options. The controls include 'Start' buttons and 'Enable' checkboxes. The 12 numbered callouts point to the following settings:

- Control panel icon (top left)
- Room temperature setpoint
- Supply air temperature setpoint
- CO₂ or VOC setpoint
- Relative humidity setpoint
- Supply air flow rate setpoint
- Extract air flow rate setpoint
- Motion detector (PIR) status
- Frost protection or window contact status
- Heating setpoint values
- Cooling setpoint values
- Save button (bottom left)

Fig. 41: Setting zone values

This screen (Fig. 41) allows you to set values for the selected zones. First you have to log in to the webserver (3.4 'Logging in to the webserver' on page 48). The screen shows only the components which the system has detected and which you have activated during zone setup; only values for these components can be adjusted.

The following setting functions are available:

- Setting the control panel (Fig. 41 /1) (3.8.9.1 'Setting up the control panel' on page 59)
- Setting the room temperature (Fig. 41 /2) (3.8.9.2 'Setting the room temperature' on page 60)
- Setting the supply air temperature (Fig. 41 /3) (3.8.9.3 'Setting the supply air temperature' on page 60)
- Setting the CO₂ or VOC value (Fig. 41 /4) (3.8.9.4 'Setting the CO₂ or VOC value' on page 61)
- Setting the relative humidity (Fig. 41 /5) (3.8.9.5 'Setting the relative humidity' on page 61)
- Setting the supply air flow rate (Fig. 41 /6) (3.8.9.6 'Setting the supply air flow rate' on page 62)
- Setting the extract air flow rate (Fig. 41 /7) (3.8.9.7 'Setting the extract air flow rate' on page 63)
- Setting the motion detector (PIR) (Fig. 41 /8) (3.8.9.8 'Setting the motion detector (PIR)' on page 63)
- Displaying the status of the frost protection or window contact (Fig. 41 /9) (3.8.9.9 'Displaying the status of the frost protection or window contact' on page 64)
- Setting the heating setpoint values (Fig. 41 /10) (3.8.9.10 'Setting the heating setpoint values' on page 64)
- Setting the cooling setpoint values (Fig. 41 /11) (3.8.9.11 'Setting the cooling setpoint values' on page 64)

3.8.9.1 Setting up the control panel

The section for setting up the control panel (Fig. 42) allows you to display and change zone values for the control panel. First you have to log in to the webserver (3.4 'Logging in to the webserver' on page 48).

Displayed zone values

- Air mode

Adjustable zone values

- Low air flow
- High air flow
- Override timeout

- Hide or show menu
 - Change password
1. ▶ On the 'Start' screen (↗ 3.2 'Start screen functions' on page 46), select a zone master.
 - ⇒ The 'Zone Overview' screen displays.
 2. ▶ To set up a control panel for a zone, select the zone (↗ 3.7 'Zone overview' on page 50).
 - ⇒ The 'Zone Setup' screen for the zone displays (↗ 3.8.9 'Setting zone values' on page 58).

Air Mode	Auto
Low Air Flow	10.0 % ● 1
High Air Flow	90.0 % ● 2
Override Timeout	10 min. ● 3
Menu Show	Hide ● 4
Password	1234 ● 5

Fig. 42: Setting up the control panel

3. ▶ Enter the zone value for the low volume flow rate as a percentage of V_{min} (Fig. 42 /1).
4. ▶ Enter the zone value for the high volume flow rate as a percentage of V_{max} (Fig. 42 /2).
5. ▶ Enter the override timeout in minutes (Fig. 42 /3).
6. ▶ To hide or show the menu click on the appropriate button Fig. 42 /4.
7. ▶ Enter a password (Fig. 42 /5).
8. ▶ Click on 'Save' (Fig. 41 /12).
 - ⇒ The settings for the room control panel have been saved.

3.8.9.2 Setting the room temperature

The section for setting the room temperature (Fig. 43) allows you to display and set the temperature values for each zone. First you have to log in to the webserver (↗ 3.4 'Logging in to the webserver' on page 48).

For zones for which there is no CP-TS control panel the setpoint value offset is 0 °C. For zones for which there is a CP-TS control panel the setpoint offset (Fig. 43/3) is shown. The current ('actual') setpoint (Abb. 43/2) is the setpoint (Fig. 43/1) minus the setpoint offset.

The PI control values are factory set, and you should not change them yourself. Only the TROX Technical Service or specifically trained experts should change the PI control values. Structural conditions (building) have to be considered.

Displayed zone values

- Room temperature actual value
- Temperature measured on the control panel
- VOC concentration on the VOC sensor

- 'Actual' (current) room temperature setpoint based on set values
- Setpoint offset

Adjustable zone values

- Room temperature setpoint value
 - PI-Reg. P-Band
 - PI-Reg. I-Time VAV
 - PI-Reg. I-Time Cool
 - PI-Reg. I-Time Heat
1. ▶ On the 'Start' screen (↗ 3.2 'Start screen functions' on page 46), select a zone master.
 - ⇒ The 'Zone Overview' screen displays.
 2. ▶ To set the room temperatures for a zone, select the zone (↗ 3.7 'Zone overview' on page 50).
 - ⇒ The 'Zone Setup' screen for the zone displays (↗ 3.8.9 'Setting zone values' on page 58).

Actual	26.3 °C ● 1
Setpoint	27.0 °C ● 2
Actual Setpoint	27.0 °C ● 3
Setpoint Offset	0.0 °C ● 4
PI Reg P-Band	7.0 °C ● 5
PI Reg I-Time VAV	100 s ● 6
PI Reg I-Time Cool	100 s ● 7
PI Reg I-Time Heat	100 s ● 7
-- more --	

Fig. 43: Setting the room temperature

3. ▶ Enter the room temperature setpoint value (Fig. 43 /1).
4. ▶ Enter the temperature for the P-Band of the PI control ('PI Regulation') (Fig. 43 /4).
5. ▶ Enter the I-Time VAV for the PI control (Fig. 43 /5).
6. ▶ Enter the integration time for cooling for PI control (Fig. 43 /6).
7. ▶ Enter the integration time for heating for PI control (Fig. 43 /7).
8. ▶ Click on 'Save' (Fig. 41 /12).
 - ⇒ The room temperature values have been set.

3.8.9.3 Setting the supply air temperature

The section for setting the supply air temperature (Fig. 44) allows you to display and set the supply air temperature for each zone. First you have to log in to the webserver (↗ 3.4 'Logging in to the webserver' on page 48).

The PI control values are factory set, and you should not change them yourself. Only the TROX Technical Service or specifically trained experts should change the PI control values. Structural conditions (building) have to be considered.

Displayed zone values

- Actual supply air temperature

Adjustable zone values

- Max. supply air temperature
 - Min. supply air temperature
 - PI-Reg. P-Band
- ▶ On the 'Start' screen (§ 3.2 'Start screen functions' on page 46), select a zone master.
 - ⇒ The 'Zone Overview' screen displays.
 - ▶ To set the supply air temperature for a zone select the zone (§ 3.7 'Zone overview' on page 50).
 - ⇒ The 'Zone Setup' screen for the zone displays (§ 3.8.9 'Setting zone values' on page 58).

	Actual	25.3 °C	
	Supply Max.	40.0 °C	1
	Supply Min.	28.0 °C	2
	PI Reg P-Band	8.0 °C	3

Fig. 44: Setting the supply air temperature

- ▶ Enter the maximum supply air temperature (Fig. 44 /1).
- ▶ Enter the minimum supply air temperature (Fig. 44 /2).
- ▶ Click on 'Save' (Fig. 41 /12).
 - ⇒ The supply air temperature values have been set.

3.8.9.4 Setting the CO₂ or VOC value

The section for setting the CO₂ or VOC value (Fig. 45) allows you to set the values for CO₂ or VOC control. First you have to log in to the webserver (§ 3.4 'Logging in to the webserver' on page 48). If the displayed CO₂ or VOC value exceeds the setpoint value, the control system will increase the volume flow rate.

The PI control values are factory set, and you should not change them yourself. Only the TROX Technical Service or specifically trained experts should change the PI control values. Structural conditions (building) have to be considered.

Displayed zone values

- CO₂ or VOC actual value

Adjustable zone values

- CO₂ or VOC setpoint value
 - PI-Reg. P-Band
 - PI-Reg. I-Time
- ▶ Log in to the webserver (§ 3.4 'Logging in to the webserver' on page 48).
 - ▶ On the 'Start' screen (§ 3.2 'Start screen functions' on page 46), select a zone master.
 - ⇒ The 'Zone Overview' screen displays.
 - ▶ To set the CO₂ or VOC value for a zone, select the zone (§ 3.7 'Zone overview' on page 50).
 - ⇒ The 'Zone Setup' screen for the zone displays (§ 3.8.9 'Setting zone values' on page 58).

	Actual	479 ppm	
	Setpoint	500 ppm	1
	PI Reg P-Band	750 ppm	2
	PI Reg I-Time	1250 s	3

Fig. 45: Setting the CO₂ value

- ▶ Enter the CO₂ or VOC setpoint value (Fig. 45 /1).
- ▶ Enter the CO₂ or VOC value for the P-Band of the PI control (Fig. 45 /2).
- ▶ Enter the integration time for PI control (Fig. 45 /3).
- ▶ Click on 'Save' (Fig. 41 /12).
 - ⇒ The CO₂ or VOC values have been set.

3.8.9.5 Setting the relative humidity

This section (Fig. 46) allows you to set the relative humidity for each zone. First you have to log in to the webserver (§ 3.4 'Logging in to the webserver' on page 48).

The PI control values are factory set, and you should not change them yourself. Only the TROX Technical Service or specifically trained experts should change the PI control values. Structural conditions (building) have to be considered.

Displayed zone values

- Actual relative humidity in %

Adjustable zone values

- Relative humidity setpoint
 - PI-Reg. P-Band
 - PI-Reg. I-Time
- ▶ Log in to the webserver (§ 3.4 'Logging in to the webserver' on page 48).
 - ▶ On the 'Start' screen (§ 3.2 'Start screen functions' on page 46), select a zone master.
 - ⇒ The 'Zone Overview' screen displays.

3. ▶ To set the relative humidity for a zone, select the zone (↪ 3.7 'Zone overview' on page 50).
 - ⇒ The 'Zone Setup' screen for the zone displays (↪ 3.8.9 'Setting zone values' on page 58).

Actual	42.6 % RH	1
Setpoint	52.0 % RH	2
PI Reg P-Band	50.0 % RH	3
PI Reg I-Time	10 s	

Fig. 46: Setting the relative humidity

4. ▶ Enter the relative humidity setpoint (Fig. 46 /1).
5. ▶ Enter the relative humidity value for the P-Band of PI control (Fig. 46 /2).
6. ▶ Enter the integration time for PI control (Fig. 46 /3).
7. ▶ Click on 'Save' (Fig. 41 /12).
 - ⇒ The relative humidity values have been set.

3.8.9.6 Setting the supply air flow rate

The section for setting the supply air flow rate (Fig. 47) allows you to display and set the supply air flow rates for each zone. You can also activate the override function for the volume flow rate. If you have enabled the override function for the volume flow rate, the resulting volume flow rate lies between the minimum volume flow rate (0%) and the maximum volume flow rate (100%). First you have to log in to the webserver (↪ 3.4 'Logging in to the webserver' on page 48).

You can test the supply air flow controller by pressing the 'Start' button for 'Testrun' (Fig. 47 /4); you can adjust the supply air flow controller by pressing the 'Start' button for 'Adaption' (Fig. 47 /5). Adaption (i.e. an adjustment run) covers the entire adjustment range, i.e. the actuator will move from one end position to the other end position. While adjustment is in progress, 'Internal Activity' is being displayed. An adjustment run ('adaption') may last for one to two minutes. The supply air flow is not being controlled while adjustment is in progress. After this procedure the actuator remains in the position indicated by the control signal.

To activate the override function for the supply air flow rate using the set percentage value, press 'Enable' (Fig. 47 /6).

The PI control values are factory set, and you should not change them yourself. Only the TROX Technical Service or specifically trained experts should change the PI control values. Structural conditions (building) have to be considered.

Displayed zone values

- Supply air volume flow rate setpoint [%]
- Supply air volume flow rate setpoint [m³/h]
- Actual position [%]
- Actual position [m³/h]

- Actual supply air flow rate [%]
- Actual supply air flow rate [m³/h]
- Nominal flow
- Override operation
- Serial no. of the supply air volume flow controller

Adjustable zone values

- Minimum supply air flow rate
- Maximum supply air flow rate
- Override value for the supply air flow rate

1. ▶ Log in to the webserver (↪ 3.4 'Logging in to the webserver' on page 48).
2. ▶ On the 'Start' screen (↪ 3.2 'Start screen functions' on page 46), select a zone master.
 - ⇒ The 'Zone Overview' screen displays.
3. ▶ To set the supply air volume flow rate for a zone, select the zone (↪ 3.7 'Zone overview' on page 50).
 - ⇒ The 'Zone Setup' screen for the zone displays (↪ 3.8.9 'Setting zone values' on page 58).

Setpoint	100.0 %
Setpoint	800 m3/h
Actual Position	100.0 %
Actual Position	94 °
Actual Flow	0.0 %
Actual Flow	0 m3/h
Nominal Flow	1000 m3/h
Min. Air Flow	200 m3/h ● 1
Max. Air Flow	800 m3/h ● 2
Override	0.0 % <input type="checkbox"/> Enable ● 3
Testrun	● Start ● 4
Adaption	● Start ● 5
Override Operation	None
Serial Number	01502-00005-000-151

Fig. 47: Setting the supply air flow rate

4. ▶ Enter the minimum supply air flow rate (Fig. 47 /1).
5. ▶ Enter the maximum supply air flow rate (Fig. 47 /2).
6. ▶ Click on 'Save' (Fig. 41 /12).
 - ⇒ The supply air flow rate values have been set.

3.8.9.7 Setting the extract air flow rate

The section for setting the extract air flow rate (Fig. 48) allows you to set the extract air flow rates for each zone. You can also activate the override function for the volume flow rate. If you have enabled the override function for the volume flow rate, the resulting volume flow rate lies between the minimum volume flow rate (0%) and the maximum volume flow rate (100%). First you have to log in to the webservice (↪ 3.4 'Logging in to the webservice' on page 48).

You can test the extract air flow controller by pressing the 'Start' button for 'Testrun' (Fig. 48 /4); you can adjust the extract air flow controller by pressing the 'Start' button for 'Adaption' (Fig. 48 /5). Adaption (i.e. an adjustment run) covers the entire adjustment range, i.e. the actuator will move from one end position to the other end position. While adjustment is in progress, 'Internal Activity' is being displayed. An adjustment run ('adaption') may last for one to two minutes. The extract air flow is not being controlled while adjustment is in progress. After this procedure the actuator remains in the position indicated by the control signal.

To activate the override function for the extract air flow rate using the set override value, press 'Enable' (Fig. 48 /6).

The PI control values are factory set, and you should not change them yourself. Only the TROX Technical Service or specifically trained experts should change the PI control values. Structural conditions (building) have to be considered.

Displayed zone values

- Extract air volume flow rate setpoint in %
- Extract air volume flow rate setpoint in m³/h
- Actual position [%]
- Actual position [m³/h]
- Actual extract air flow rate in %
- Actual extract air flow rate in m³/h
- Nominal flow
- Override operation
- Serial no. of the extract air volume flow controller

Adjustable zone values

- Minimum extract air flow rate
 - Maximum extract air flow rate
 - Override value for the extract air volume flow rate
1. ▶ Log in to the webservice (↪ 3.4 'Logging in to the webservice' on page 48).
 2. ▶ On the 'Start' screen (↪ 3.2 'Start screen functions' on page 46), select a zone master.
 - ⇒ The 'Zone Overview' screen displays.
 3. ▶ To set the extract air flow rate for a zone, select the zone (↪ 3.7 'Zone overview' on page 50).
 - ⇒ The 'Zone Setup' screen for the zone displays (↪ 3.8.9 'Setting zone values' on page 58).

Setpoint	100.0%
Setpoint	800m3/h
Actual Position	100.0%
Actual Position	94°
Actual Flow	0.0%
Actual Flow	0m3/h
Nominal Flow	1000m3/h
Min. Air Flow	200 m3/h (1)
Max. Air Flow	800 m3/h (2)
Override	0.0% (3) <input type="button" value="Enable"/>
Testrun	(4) <input type="button" value="Start"/>
Adaption	(5) <input type="button" value="Start"/>
Override Operation	None
Serial Number	01502-00007-000-139
-- less --	

Fig. 48: Setting the extract air flow rate

4. ▶ Enter the minimum extract air flow rate (Fig. 48 /1).
5. ▶ Enter the maximum extract air flow rate (Fig. 48 /2).
6. ▶ Click on 'Save' (Fig. 41 /12).
 - ⇒ The extract air flow rate values have been set.

3.8.9.8 Setting the motion detector (PIR)

The motion detector is a PIR sensor. The PIR sensor is automatically activated as soon as a person in a room moves. If the sensor does not detect any other movement during the set activation time, it is reset. You can set the activation time using the webservice (↪ 3.8.10.13 'Setting the PIR run down time' on page 69).

The section for setting the motion detector (Fig. 49) allows you to see activation information for each zone and to set a minimum supply air flow rate. This minimum supply air flow rate applies when there are people in a room.

A motion detector is recommended for rooms that are only rarely used. For rooms that are used every day we recommend a schedule or constant control.

1. ▶ On the 'Start' screen (↪ 3.2 'Start screen functions' on page 46), select a zone master.
 - ⇒ The 'Zone Overview' screen displays.
2. ▶ To set the motion detector for a zone, select the zone (↪ 3.7 'Zone overview' on page 50).
 - ⇒ The 'Zone Setup' screen for the zone displays.

Actual	Not Active
Supply Min. Air Flow	500 m3/h (1)

Fig. 49: Setting the motion detector

3. ▶ Enter the minimum supply air flow rate (Fig. 49 /1).

4. ▶ Click on 'Save' (Fig. 41 /12).
 - ⇒ The supply air flow rate has been saved.

3.8.9.9 Displaying the status of the frost protection or window contact

This section (Fig. 50) of the zone settings allows you to view the current status of the frost protection or window contact. The status is either 'Closed' or 'Open'.

In the zone master settings you can choose between 'Normal operation' and 'Closed volume flow controller'.

1. ▶ On the 'Start' screen (3.2 'Start screen functions' on page 46), select a zone master.
 - ⇒ The 'Zone Overview' screen displays.
2. ▶ To view the status of the frost protection or window contact for a zone, select the zone (3.7 'Zone overview' on page 50).
 - ⇒ The 'Zone Setup' screen for the zone displays (3.8.9 'Setting zone values' on page 58).



Fig. 50: Status of the frost protection or window contact

3. ▶ The status of the frost protection or window contact is displayed (Fig. 50).

3.8.9.10 Setting the heating setpoint values

The section for setting the supply air heating valve (Fig. 51) allows you to view the setpoint for the heating valve opening. It also allows you to set and enable an override value for the heating valve. If you have enabled the override function for the heating valve, the resulting valve opening lies between the minimum opening (0%, i.e. closed) and the maximum opening (100%, i.e. fully open). First you have to log in to the webserver (3.4 'Logging in to the webserver' on page 48).

You can test the heating valve actuator by pressing the 'Start' button for 'Testrun' (Fig. 51 /2); you can adjust the heating valve actuator by pressing the 'Start' button for 'Adaption' (Fig. 51 /3). Adaption (i.e. an adjustment run) covers the entire adjustment range, i.e. the actuator will move from one end position to the other end position. While adjustment is in progress, 'Internal Activity' is being displayed. An adjustment run ('adaption') may last for one to two minutes. The heating valve is not being controlled while adjustment is in progress. After this procedure the actuator remains in the position indicated by the control signal.

To activate the override function for the heating valve using the set override value, press 'Enable' (Fig. 51 /4).

1. ▶ On the 'Start' screen (3.2 'Start screen functions' on page 46), select a zone master.
 - ⇒ The 'Zone Overview' screen displays.

2. ▶ To set the supply air heating valve for a zone, select the zone (3.7 'Zone overview' on page 50).
 - ⇒ The 'Zone Setup' screen for the zone displays.

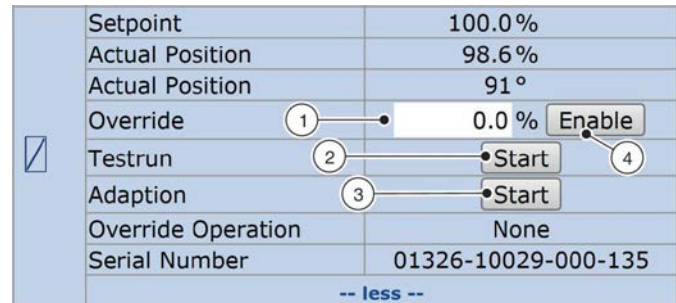

Fig. 51: Setting the heating setpoint values

3. ▶ Click on 'Save' (Fig. 41 /12).
 - ⇒ The override value for the heating valve has been saved.

3.8.9.11 Setting the cooling setpoint values

The section for setting the supply air cooling valve (Fig. 52) allows you to view the setpoint for the cooling valve opening. It also allows you to set and enable an override value for the cooling valve. If you have enabled the override function for the cooling valve, the resulting valve opening lies between the minimum opening (0%, i.e. closed) and the maximum opening (100%, i.e. fully open). First you have to log in to the webserver (3.4 'Logging in to the webserver' on page 48).

You can test the cooling valve actuator by pressing the 'Start' button for 'Testrun' (Fig. 52 /2); you can adjust the cooling valve actuator by pressing the 'Start' button for 'Adaption' (Fig. 52 /3). Adaption (i.e. an adjustment run) covers the entire adjustment range, i.e. the actuator will move from one end position to the other end position. While adjustment is in progress, 'Internal Activity' is being displayed. An adjustment run ('adaption') may last for one to two minutes. The cooling valve is not being controlled while adjustment is in progress. After this procedure the actuator remains in the position indicated by the control signal.

To activate the override function for the cooling valve using the set override value, press 'Enable' (Fig. 52 /4).

1. ▶ On the 'Start' screen (3.2 'Start screen functions' on page 46), select a zone master.
 - ⇒ The 'Zone Overview' screen displays.
2. ▶ To set the supply air cooling valve for a zone, select the zone (3.7 'Zone overview' on page 50).
 - ⇒ The 'Zone Setup' screen for the zone displays.



Setpoint	0.0 %
Actual Position	0.0 %
Actual Position	0 °
Override	0.0 % <input type="button" value="Enable"/>
Testrun	<input type="button" value="Start"/>
Adaption	<input type="button" value="Start"/>
Override Operation	None
Serial Number	01305-10422-000-160
-- less --	

Fig. 52: Setting the cooling setpoint values

3. ▶ Click on 'Save' (Fig. 41).
 - ⇒ The override value for the cooling valve has been saved.

3.8.10 Configuring the zone master

ZoneMaster Setup

Settings	Description	Value
	Minimum Supply Air Temperature	16.0 °C
	Max. Water Temp. Cooling	30.0 °C
	Min. Water Temp. Heating	10.0 °C
	Fire Mode Operation Supply	Closed <input type="button" value="v"/>
	Fire Mode Operation Extract	Closed <input type="button" value="v"/>
	Setpoint Offset Range	1.0 °C
	Open Window VAV operation	Closed <input type="button" value="v"/>
	Regulation Cooling Sequence	Air, Water <input type="button" value="v"/>
	Min. Supply Fan Speed	0.0 %
	Max. Supply Fan Speed	100.0 %
	Min. Extract Fan Speed	0.0 %
	Max. Extract Fan Speed	100.0 %
	Fan Speed Supply PI Controller P-value	10.0 %
	Fan Speed Supply Pressure PI Controller P-value	40.0 %
	Fan Speed Supply PI Controller I-time	100 s
	Fan Speed Extract PI Controller P-value	10.0 %
	Fan Speed Extract Pressure PI Controller P-value	40.0 %
	Fan Speed Extract PI Controller I-time	100 s
	Pump Speed Cooling PI Controller P-value	10.0 %
	Pump Speed Cooling PI Controller I-time	100 s
	Outdoor Temperature Sensor	<input checked="" type="checkbox"/>
	Water Temperature Sensor	No <input type="button" value="v"/>
	Hotel Room Reset Hour	10:00 h
	Hotel Room Temp. Setpoint	21.0 °C
	PIR Run-on Time	600 s
Output	Description	Status
Aout1	Supply Fan Speed	0.0 %
Aout2	Extract Fan Speed	0.0 %
Aout3	Cooling Pump Speed	0.0 %
Dout1	Start Pump Cooling	Off
Dout2	Start Pump Heating	Off
Dout3	Start Fans	On
Dout4	A Alarm Active	Off
Dout5	B Alarm Active	Off
Input	Description	Status
Din1	Supply Fan Alarm	Open
Din2	Extract Fan Alarm	Open
Din3	Start Zones	Closed
Din4	Fire	Closed
Din5	Open Dampers	Open
Din6	Close Dampers	Open
Tin1	Water Temperature	25.8 °C
Tin2	Outdoor Temperature	24.9 °C

Fig. 53: Configuring the zone master

This screen (Fig. 53) allows you to set values for a zone master. First you have to log in to the webserver (↪ 3.4 'Logging in to the webserver' on page 48).

The following setting functions are available:

- Setting the minimum supply air temperature (↗ 3.8.10.1 'Setting the minimum supply air temperature' on page 66)
- Setting the water temperature (↗ 3.8.10.2 'Setting the water temperature' on page 66)
- Settings for fire mode operation (↗ 3.8.10.3 'Settings for fire mode operation' on page 66)
- Setting a setpoint offset range (↗ 3.8.10.4 'Setting a setpoint offset range' on page 67)
- Settings for an open window (↗ 3.8.10.5 'Settings for an open window' on page 67)
- Setting a cooling sequence (↗ 3.8.10.6 'Setting a cooling sequence' on page 67)
- Setting the fan speed (↗ 3.8.10.7 'Setting the fan speed' on page 67)
- Setting supply air and extract air pressures (↗ 3.8.10.8 'Setting supply air and extract air pressures' on page 68)
- Settings for PI control (↗ 3.8.10.9 'Settings for PI control' on page 68)
- Activating an outdoor air temperature sensor (↗ 3.8.10.10 'Activating an outdoor air temperature sensor' on page 69)
- Activating a water temperature sensor (↗ 3.8.10.11 'Activating a water temperature sensor' on page 69)
- Settings for hotel rooms (↗ 3.8.10.12 'Settings for hotel rooms' on page 69)
- Setting the PIR run down time (called 'run-on time' in the software) (↗ 3.8.10.13 'Setting the PIR run down time' on page 69)
- Displaying input and output status information (↗ 3.8.10.14 'Displaying input and output status information' on page 70)

3.8.10.1 Setting the minimum supply air temperature

The minimum supply air temperature is measured in the ventilation duct. The 'ZoneMaster Setup' screen allows you to set a minimum supply air temperature.

1. ▶ On the 'Start' screen (↗ 3.2 'Start screen functions' on page 46), click on the Tools symbol.
⇒ The Service screen displays.
2. ▶ Click on 'ZoneMaster'.
⇒ The 'ZoneMaster Setup' screen displays.

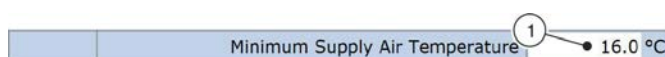

Fig. 54: Setting the minimum supply air temperature

3. ▶ Enter the minimum supply air temperature (Fig. 54 /1).
4. ▶ Click on 'Save'.
⇒ The minimum supply air temperature has been saved.

3.8.10.2 Setting the water temperature

You can set the maximum and minimum water temperatures only if a water temperature sensor has been connected to the zone master. The 'ZoneMaster Setup' screen allows you to set the maximum water temperature for cooling and the minimum water temperature for heating.

Cooling operation ends when the water temperature exceeds the set maximum water temperature for cooling. Heating operation starts when the minimum water temperature for heating is reached.

1. ▶ On the 'Start' screen (↗ 3.2 'Start screen functions' on page 46), click on the Tools symbol.
⇒ The Service screen displays.
2. ▶ Click on 'ZoneMaster'.
⇒ The 'ZoneMaster Setup' screen displays.

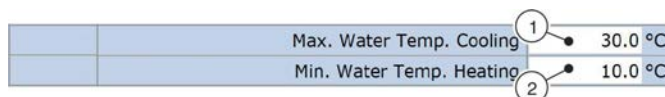

Fig. 55: Setting the water temperature

3. ▶ Enter the maximum water temperature for cooling (Fig. 55 /1).
4. ▶ Enter the minimum water temperature for heating (Fig. 55 /2).
5. ▶ Click on 'Save'.
⇒ The maximum and minimum water temperatures have been saved.

3.8.10.3 Settings for fire mode operation

This operating mode allows you to extract smoke from zone sections or to isolate zone sections in the event of a fire. This operating mode does not replace any legally required fire protection measures, but is only an additional measure. The 'ZoneMaster Setup' screen allows you to fully open (maximum volume flow rate) or close supply air and extract air dampers independent of each other by setting the respective volume flow rates.

1. ▶ On the 'Start' screen (↗ 3.2 'Start screen functions' on page 46), click on the Tools symbol.
⇒ The Service screen displays.

- Click on 'ZoneMaster'.
 - The 'ZoneMaster Setup' screen displays.

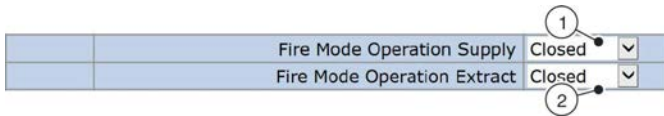

Fig. 56: Settings for fire mode operation

- Select a setting for the supply air from the drop down list (Fig. 56 /1): either 'Max. air' or 'Closed'.
 - The supply air terminal devices will remain closed or fully open during a fire alarm.
- Select a setting for the extract air from the drop down list (Fig. 56 /2): either 'Max. air' or 'Closed'.
 - The extract air terminal devices will remain closed or fully open during a fire alarm.
- Click on 'Save'.
 - The fire operating mode settings have been saved.

3.8.10.4 Setting a setpoint offset range

The 'Setpoint Offset Range' indicates the maximum range for a room temperature setpoint change that has been set on the room control panel. For example: If the 'Setpoint Offset Range' is 5 °C, the setpoint for the temperature set on the room control panel can be anything from -5 °C to 5 °C.

- On the 'Start' screen (↗ 3.2 'Start screen functions' on page 46), click on the Tools symbol.
 - The Service screen displays.
- Click on 'ZoneMaster'.
 - The 'ZoneMaster Setup' screen displays.



Fig. 57: Setting a setpoint offset range

- Enter a temperature (Fig. 57 /1).
- Click on 'Save'.
 - The setpoint range has been set.

3.8.10.5 Settings for an open window

This screen (Fig. 58) allows you to set the action for a zone module in case someone opens a window: either close the supply air damper blade or maintain normal ventilation.

- On the 'Start' screen (↗ 3.2 'Start screen functions' on page 46), click on the Tools symbol.
 - The Service screen displays.

- Click on 'ZoneMaster'.
 - The 'ZoneMaster Setup' screen displays.

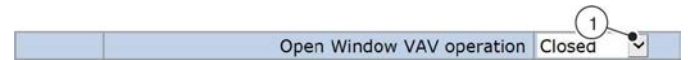

Fig. 58: Settings for an open window

- Select a setting for the supply air flow controller from the drop down list (Fig. 58 /1): either 'Closed' to close the controller, or 'Normal' for normal ventilation.
- Click on 'Save'.
 - The controller setting for an open window has been saved.

3.8.10.6 Setting a cooling sequence

You can define the order in which cooling should occur. You can choose between 'Air, Water' and 'Water, Air'. 'Air, Water' means that for cooling first the volume flow rate (i.e. air) is changed. If this is not sufficient, the heat exchanger may additionally be switched on. 'Water, Air' means that for cooling first the heat exchanger is (i.e. water) is used. If this is not sufficient, the volume flow rate may additionally be changed.

- On the 'Start' screen (↗ 3.2 'Start screen functions' on page 46), click on the Tools symbol.
 - The Service screen displays.
- Click on 'ZoneMaster'.
 - The 'ZoneMaster Setup' screen displays.

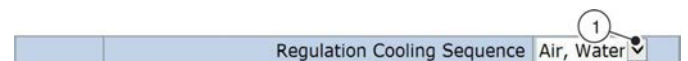

Fig. 59: Setting a cooling sequence

- Select a setting from the drop down list (Fig. 59 /1): either 'Water, Air' to close the supply air damper, or 'Air, Water' to maintain normal ventilation.
- Click on 'Save'.
 - The cooling sequence has been set.

3.8.10.7 Setting the fan speed

You can set any speed from 0% to 100% for supply air fans and extract air fans. Setting the fan speed allows you to save energy or to limit the duct pressure.

- On the 'Start' screen (↗ 3.2 'Start screen functions' on page 46), click on the 'Tools' symbol.
 - The Service screen displays.
- Click on 'ZoneMaster'.
 - The 'ZoneMaster Setup' screen displays.

1	Min. Supply Fan Speed	0.0 %
2	Max. Supply Fan Speed	100.0 %
3	Min. Extract Fan Speed	0.0 %
4	Max. Extract Fan Speed	100.0 %

Fig. 60: Setting the fan speed

3. ▶ Enter the minimum speed for the supply air fan as a percentage into the 'Min. Supply Fan Speed' field (Fig. 60 /1).
4. ▶ Enter the maximum speed for the supply air fan as a percentage into the 'Max. Supply Fan Speed' field (Fig. 60 /2).
5. ▶ Enter the minimum speed for the extract air fan as a percentage into the 'Min. Extract Fan Speed' field (Fig. 60 /3).
6. ▶ Enter the maximum speed for the extract air fan as a percentage into the 'Max. Extract Fan Speed' field (Fig. 60 /4).
7. ▶ Click on 'Save'.
 - ⇒ The fan speed limits have been saved.

3.8.10.8 Setting supply air and extract air pressures

This section (Fig. 61) allows you to set the maximum supply air pressure and the maximum extract air pressure. These values depend on the technical data for the supply air fan and extract air fan.

1. ▶ On the 'Start' screen (↗ 3.2 'Start screen functions' on page 46), click on the Tools symbol.
 - ⇒ The Service screen displays.
2. ▶ Click on 'ZoneMaster'.
 - ⇒ The 'ZoneMaster Setup' screen displays.

1	Max. Supply Pressure	1000 Pa
2	Max. Extract Pressure	1000 Pa

Fig. 61: Setting supply air and extract air pressures

3. ▶ Enter the maximum supply air pressure (Fig. 61 /1).
4. ▶ Enter the maximum extract air pressure (Fig. 61 /2).
5. ▶ Click on 'Save'.
 - ⇒ The pressure values have been saved.

3.8.10.9 Settings for PI control

This section (Fig. 62) allows you to adjust the P-values for the extract air fan speed, the supply air pressure, the extract air pressure and the pump speed.

The PI control values are factory set, and you should not change them yourself. Otherwise PI control may become unstable. Only the TROX Technical Service or specifically trained experts should change the PI control values. Structural conditions (building) have to be considered.

1. ▶ On the 'Start' screen (↗ 3.2 'Start screen functions' on page 46), click on the Tools symbol.
 - ⇒ The Service screen displays.
2. ▶ Click on 'ZoneMaster'.
 - ⇒ The 'ZoneMaster Setup' screen displays.

1	Fan Speed Supply PI Controller P-value	10.0 %
2	Fan Speed Supply Pressure PI Controller P-value	40.0 %
3	Fan Speed Supply PI Controller I-time	100 s
4	Fan Speed Extract PI Controller P-value	10.0 %
5	Fan Speed Extract Pressure PI Controller P-value	40.0 %
6	Fan Speed Extract PI Controller I-time	100 s
7	Pump Speed Cooling PI Controller P-value	10.0 %
8	Pump Speed Cooling PI Controller I-time	100 s

Fig. 62: Settings for PI control

3. ▶ Write down the current values for PI control (Fig. 62).
4. ▶ Enter the P-value for the supply air fan speed (Fig. 62 /1).
5. ▶ Enter the P-value for the supply air pressure (Fig. 62 /2).
6. ▶ Enter the integration time for the supply air fan speed (Fig. 62 /3).
7. ▶ Enter the P-value for the extract air fan speed (Fig. 62 /4).
8. ▶ Enter the P-value for the extract air pressure (Fig. 62 /5).
9. ▶ Enter the integration time for the extract air fan speed (Fig. 62 /6).
10. ▶ Enter the P-value for the cooling pump speed (Fig. 62 /7).
11. ▶ Enter the integration time for the pump speed (Fig. 62 /8).
12. ▶ Click on 'Save'.
 - ⇒ The settings for the PI controller have been saved.

3.8.10.10 Activating an outdoor air temperature sensor

This section (Fig. 63) allows you to activate or deactivate an outdoor air temperature sensor connected to the zone master. The temperature measured by the outdoor air temperature sensor is used as a reference value for summer and winter compensation.

- ▶ On the 'Start' screen (§ 3.2 'Start screen functions' on page 46), click on the Tools symbol.

⇒ The Service screen displays.

- ▶ Click on 'ZoneMaster'.

⇒ The 'ZoneMaster Setup' screen displays.



Fig. 63: Activating an outdoor air temperature sensor

- ▶ If you want to activate the outdoor air temperature sensor connected to the zone master, check the box (Fig. 63 /1).

- ▶ Click on 'Save'.

⇒ The outdoor air sensor on the zone master has been activated (or deactivated, if you have unchecked the box).

3.8.10.11 Activating a water temperature sensor

This section (Fig. 64) allows you to configure a water temperature sensor. Select a setting from the drop down list (Fig. 64 /1): 'No', 'Cooling' or 'Combi-Coil'.

If you want to deactivate the water temperature sensor, select 'No'. If you want to activate the water temperature sensor, select 'Cooling'. As soon as the water temperature exceeds the preset maximum water temperature for cooling, the cooling valve closes, and cooling mode stops.

If you want to combine heating and cooling operation (heating and cooling coils), select , 'Combi-Coil'. As soon as the water temperature exceeds the preset minimum water temperature for heating, the heating valve opens and heating operation starts. Whether cooling mode or heating mode is used in a particular temperature range depends on the control settings.

- ▶ On the 'Start' screen (§ 3.2 'Start screen functions' on page 46), click on the Tools symbol.

⇒ The Service screen displays.

- ▶ Click on 'ZoneMaster'.

⇒ The 'ZoneMaster Setup' screen displays.

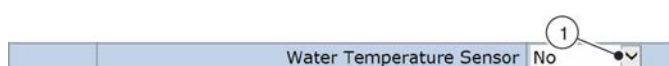

Fig. 64: Activating a water temperature sensor

- ▶ Select a setting from the drop down list (Fig. 64 /1): 'No', 'Cooling' or 'Combi-Coil'.

- ▶ Click on 'Save'.

⇒ The water temperature sensor has been configured.

3.8.10.12 Settings for hotel rooms

This section (Fig. 65) allows you to set a reset time for the temperature setpoint value. When the reset time is reached, all zone modules configured for hotel guest rooms will be reset to the temperature setpoint (Fig. 65 /2). For activating the hotel mode for a zone see § 3.8.8 'Hotel mode' on page 58 .

- ▶ On the 'Start' screen (§ 3.2 'Start screen functions' on page 46), click on the Tools symbol.

⇒ The Service screen displays.

- ▶ Click on 'ZoneMaster'.

⇒ The 'ZoneMaster Setup' screen displays.



Fig. 65: Settings for hotel rooms

- ▶ Enter the reset time for the temperature setpoint value (Fig. 65 /1).

- ▶ Enter the temperature setpoint for hotel guest rooms (Fig. 65 /2).

- ▶ Click on 'Save'.

⇒ The values for hotel guest rooms have been set.

3.8.10.13 Setting the PIR run down time

This section (Fig. 66) allows you to set the PIR run down time (called 'run-on time' in the software). The PIR run down time is the period of time after which reduced operation is resumed. Note that PIR run down time begins when the activation time of the motion detector ends. This is indicated by the opening of the PIR contact on the zone module. The PIR run down time is the sum of the down time in the zone master and the run down time in the motion detector.

- ▶ On the 'Start' screen, click on the Tools symbol.

⇒ The Service screen displays.

- ▶ Click on 'ZoneMaster'.

⇒ The 'ZoneMaster Setup' screen displays.



Fig. 66: Setting the PIR run down time (called 'run-on time' in the software)

- ▶ Enter the number of seconds (Fig. 66 /1).

4. ▶ Click on 'Save'.

⇒ The PIR run down time has been set.

3.8.10.14 Displaying input and output status information

This section (Fig. 67) allows you to view status information for the inputs and outputs on the zone master.

1. ▶ On the 'Start' screen (↪ 3.2 'Start screen functions' on page 46), click on the Tools symbol.

⇒ The Service screen displays.

2. ▶ Click on 'ZoneMaster'.

⇒ The 'ZoneMaster Setup' screen displays.

Output	Description	Status
Aout1	Supply Fan Speed	0.0 %
Aout2	Extract Fan Speed	0.0 %
Aout3	Cooling Pump Speed	52.6 %
Dout1	Start Pump Cooling	On
Dout2	Start Pump Heating	Off
Dout3	Start Fans	On
Dout4	A Alarm Active	Off
Dout5	B Alarm Active	Off
Input	Description	Status
Din1	Supply Fan Alarm	Open
Din2	Extract Fan Alarm	Open
Din3	Start Zones	Closed
Din4	Fire	Closed
Din5	Open Dampers	Open
Din6	Close Dampers	Open
Tin1	Water Temperature	24.5 °C
Tin2	Outdoor Temperature	25.5 °C
PTH2	Supply Pressure	-1 Pa
PTH1	Extract Pressure	2 Pa

Fig. 67: Input and output status information

The following status information is available:

Supply air and extract air fan speed

This section (Fig. 67 /1) allows you to view the speeds of the supply air fan, the extract air fan and the cooling pump.

Activation

This section (Fig. 67 /2) allows you to view the status of the digital outputs for cooling and heating and for an external fan. If a zone on the zone master is in cooling mode or heating mode, the corresponding digital output is activated. If there are several zones, cooling or heating is based on the status of the majority of zones.

Alarm messages

This section (Fig. 67 /3) allows you to view the status of digital outputs Dout4 and Dout5. You can use outputs Dout4 and Dout5 for alarm indicator lights or for signalling to the central BMS.

A alarm (Dout4)

- 'A alarm' refers to a (serious) system error. If there is an A alarm, all zone modules connected to the zone master will be switched off.

B alarm (Dout5)

- 'B alarm' refers to an error on a zone module. If there is a B alarm, the affected zone module will be switched off.

Supply air and extract air fan alarm (NO)

This section (Fig. 67 /4) allows you to view the status of digital inputs Din1 and Din2. A closed input contact leads to an A alarm in the zone master; this will additionally be signalled to digital output Dout4.

External activation and fire alarm (NC)

This section (Fig. 67 /5) allows you to see the status of digital inputs Din3 (external activation) and Din4 (fire alarm). If the Din3 contact opens, the volume flow controllers connected to the zone modules are closed, and the zone modules will go into standby mode. If the contact closes again, the system resumes normal mode. If the Din4 contact opens, the system goes into fire alarm mode. Depending on what has been preset (↪ 3.8.10.3 'Settings for fire mode operation' on page 66), the volume flow controllers will either close or open (override control). If the contact closes again, the system resumes normal mode.

Override control for volume flow controllers, V_{max} / V_{min} (NO)

This section (Fig. 67 /6) allows you to view the status of inputs Din5 and Din6. A closed contact on Din5 leads to V_{max} being set (override control), a closed contact on Din6 leads to V_{min} being set (override control) on the volume flow controllers for the zones.

External temperatures

This section (Fig. 67 /7) allows you to view the water temperature and the outdoor air temperature measured by the PT1000 temperature sensors connected to Tin1 and Tin2. The two PT1000 temperature sensors allow you to measure the temperature of the heating fluid and of the cooling fluid as well as the outdoor air temperature ↪ 3.8.10.10 'Activating an outdoor air temperature sensor' on page 69 ↪ 3.8.10.11 'Activating a water temperature sensor' on page 69 .

Supply air and extract air pressures

This section (Fig. 67 /8) allows you to view the supply air pressure and the extract air pressure. The pressure sensors are connected to the Modbus interface ↪ 3.8.10.8 'Setting supply air and extract air pressures' on page 68 .

3.8.11 Summer and winter compensation

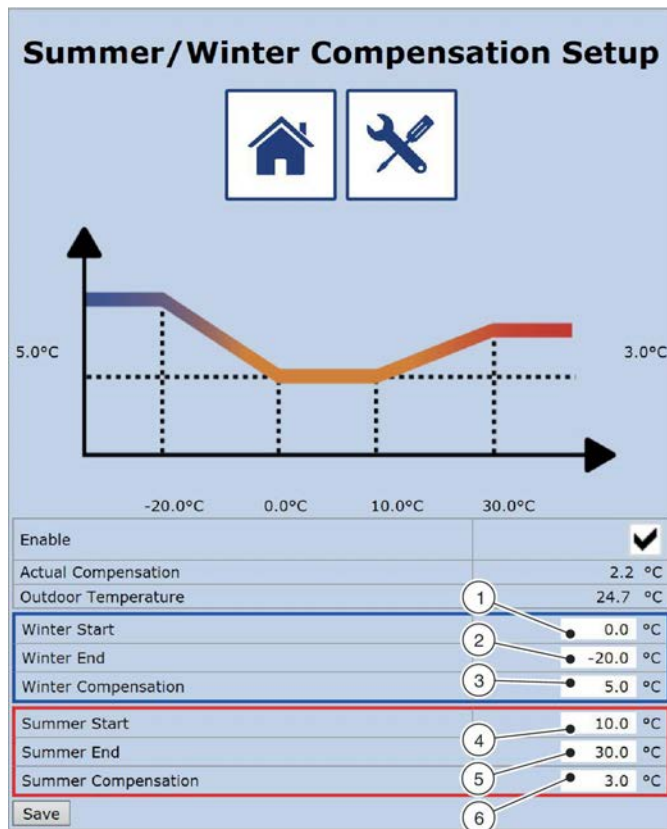

Fig. 68: Summer and winter compensation

The 'Summer/Winter Compensation Setup' screen allows you to set and activate temperature compensation for summer mode and winter mode. This function is only available if an outdoor temperature sensor has been connected to the zone master and activated. If this function is active, the temperature setpoint will be corrected in summer or winter based on the outdoor air temperature. If summer compensation is active and if the temperature is in the range between the summer start temperature and the summer end temperature, the temperature setpoint will be reduced by the summer compensation value. If winter compensation is active and if the temperature is in the range between the winter start temperature and the winter end temperature, the temperature setpoint will be increased by the winter compensation value.

Important note

Summer or winter compensation is possible only if an outdoor air temperature sensor (PT1000) is connected to input T2 on the zone master. This sensor should ideally be fixed to the north side of the building.

- ▶ On the 'Start' screen (↪ 3.2 'Start screen functions' on page 46), click on the Tools symbol.
⇒ The Service screen displays.
- ▶ Click on 'Summer/Winter Compensation'.

⇒ The 'Summer/Winter Compensation Setup' screen (Fig. 68) displays.

- ▶ Enter the outdoor air temperature at which winter compensation shall start (Fig. 68 /1).
- ▶ Enter the outdoor air temperature at which winter compensation shall end (Fig. 68 /2).
- ▶ Enter the maximum winter compensation value for the setpoint (Fig. 68 /3).
- ▶ Enter the outdoor air temperature at which summer compensation shall start (Fig. 68 /4).
- ▶ Enter the outdoor air temperature at which summer compensation shall end (Fig. 68 /5).
- ▶ Enter the maximum summer compensation value for the setpoint (Fig. 68 /6).
- ▶ Click on 'Save'.

⇒ Summer and winter compensation have been set.

3.8.12 Network connection settings

Personnel:

- Network administrator

The 'TCP/IP BMS' connection on the zone master requires an IP address; you can enter a static IP address or have the system assign a dynamic (DHCP) IP address.

If you connect the zone master to a personal computer, using a network cable, you need to set the static IP address on the zone master.

Having the IP address assigned dynamically (DHCP) is recommended only if you can verify the IP address that the zone master assigns. If you don't know the IP address, use the 'IP-Config' software to reset the IP address.

- ▶ On the 'Start' screen (↪ 3.2 'Start screen functions' on page 46), click on the Tools symbol.
⇒ The Service screen displays.

2. ▶ Click on 'Network Connection'.

⇒ The 'Network Connection' screen displays (Fig. 69).

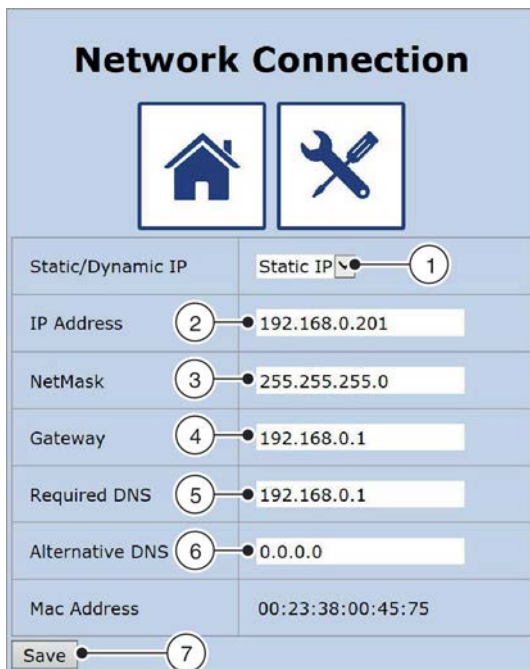

Fig. 69: Network connection settings

Setting the static IP address

3. ▶ Select 'Static IP' from the drop down list (Fig. 69 /1).
 4. ▶ Enter the static IP address (Fig. 69 /2). The default IP address is 192.168.0.201.
 5. ▶ Enter the subnet mask (Fig. 69 /3).
 6. ▶ Enter a gateway (Fig. 69 /4).
 7. ▶ Enter a DNS (Fig. 69 /5).
 8. ▶ Enter an alternative DNS (Fig. 69 /6).
 9. ▶ Click on 'Save' (Fig. 69 /7).
- ⇒ The static network connection has been set up.

Setting a dynamic IP address

1. ▶ Select 'Dynamic IP' from the drop down list.

⇒ The IP address of the zone master is automatically assigned.
2. ▶ Click on 'Save'.

⇒ The dynamic network connection has been set up.

3.8.13 Firmware update

You can update the firmware for the zone master, the zone module and the control panel. The latest firmware version is available for download on the TROX GmbH website. The firmware consists of two files: 'version.crc' and 'zonemaster_update_v313.tar.gz' for updating the zone master, the zone module and the control panel. You need an SD card (8 GB max.) to which you can save the downloaded firmware files.

1. ▶ Save 'version.crc' and 'zonemaster_update_v313.tar.gz' to the uppermost directory on your SD card.

The file names used here are examples; the actual file names may vary.

2. ▶ Go to the zone master and open the 'Start' screen (↩ 3.2 'Start screen functions' on page 46).
3. ▶ Insert the SD card into the slot on the zone master.

⇒ The screen in Fig. 70 with the number of the latest firmware version displays.

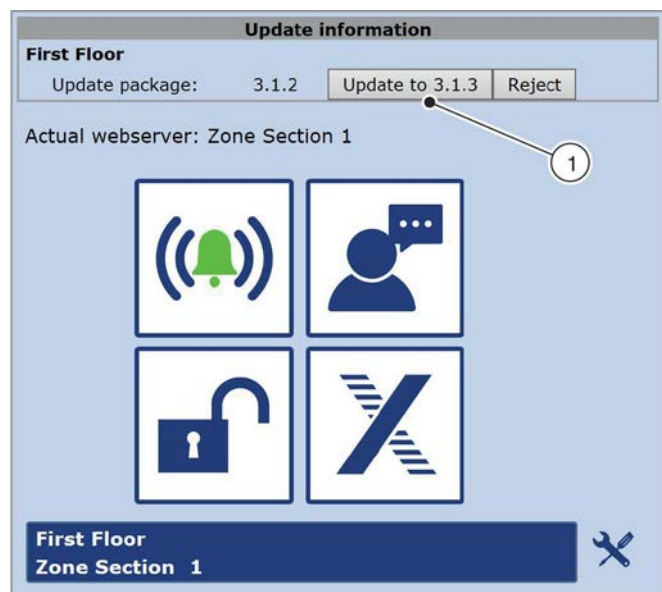

Fig. 70: Firmware update

4. ▶ Click on the button (Fig. 70 /1).

⇒ The firmware is being downloaded and installed.

i

Do not remove the SD card and do not interrupt the power supply while the firmware is being installed.

5. ▶ When the installation is complete, remove the SD card.

⇒ The latest firmware version has been installed.

3.8.14 Displaying a zone overview

The 'Zone Overview' screen (Fig. 71) allows you to view all values that have been set for a particular zone. Viewing zone values does not require you to log in to X-AIRCONTROL.



Callout	Parameter	Unit	Value
1	Air Mode		Auto
	Low Air Flow		10.0%
	High Air Flow		90.0%
	Override Timeout		10 min.
2	Actual		26.5 °C
	Setpoint		20.0 °C
	Actual Setpoint		24.8 °C
3	Actual		25.3 °C
4	Actual		1196 ppm
5	Actual		43.9% RH
6	Setpoint		0.0%
	Supply1		200 m ³ /h
7	Setpoint		0.0%
	Extract		200 m ³ /h
8	Actual		Not Active
9	Actual		Closed
10	Setpoint		100.0%
11	Setpoint		0.0%

Fig. 71: Zone overview (no password required)

The following values may be displayed:

- Values set with the control panel (Fig. 71 /1)
 - Air mode
 - Low air flow
 - High air flow
 - Override timeout
- Room temperature (Fig. 71 /2)
 - Room temperature actual value
 - Room temperature setpoint value
 - Room temperature actual setpoint value
- Supply air temperature (Fig. 71 /3)
- CO₂ or VOC value (Fig. 71 /4)
- Humidity (Fig. 71 /5)
- Supply air volume flow rate (Fig. 71 /6)
 - Setpoint value [%]
 - Setpoint value [m³/h]
- Extract air volume flow rate (Fig. 71 /7)
 - Setpoint value [%]
 - Setpoint value [m³/h]
- PIR sensor (Fig. 71 /8)
- Frost sensor/window contact (Fig. 71 /9)
- Heating valve position [%] (Fig. 71 /10)
- Cooling valve position [%] (Fig. 71 /11)

1. ▶ On the 'Start' screen (↪ 3.2 'Start screen functions' on page 46), select a zone master.
 - ⇒ The 'Zone Overview' screen displays.
2. ▶ Select a zone.
 - ⇒ The values for the selected zone (↪ 3.2 'Start screen functions' on page 46) are displayed.
3. ▶ See the values for the selected zone (Fig. 71 /1 – 11).

4 Configuring system components on the control panel

4.1 Switching the control panel on

The control panel is activated as soon as you switch on the supply voltage. The 'X-AIRCONTROL' logo (Fig. 72) is displayed.



Fig. 72: X-AIRCONTROL

After 5 seconds the 'Start' screen displays (↗ 4.2 'Start screen functions' on page 74).

4.2 Start screen functions

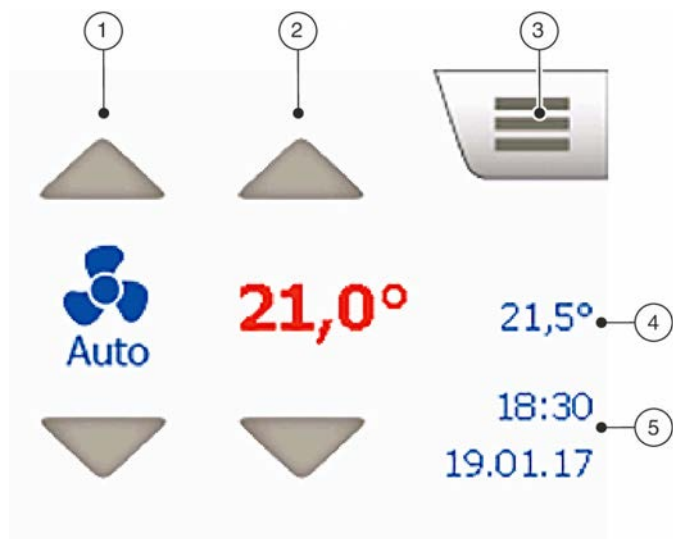

Fig. 73: Start screen

- 1 Setting the volume flow rate and viewing current settings ↗ 4.5.1 'Setting the volume flow rate' on page 84
- 2 Setting the temperature setpoint value and viewing the current setpoint value ↗ 4.5.2 'Setting a temperature setpoint value' on page 85
- 3 Opening the main menu
- 4 Current room temperature
- 5 Date and time

This screen (Fig. 73) shows the room temperature actual and setpoint values, the override timeout, and the current date and time. The ▲ and ▼ buttons allow you to change volume flow rate and room temperature. Use the menu button to open the main menu. The main menu allows you to access all functions and submenus of the control panel.

The ↗ 'Menu structure' on page 75 shows the menu structure of the control panel. The menu structure shows you where to find each control panel function.

Menu structure

Main menu	Submenu 1	Submenu 2	Submenu 3	
Start	–	–	–	
(⚙ 4.4.4 'Setting up schedules' on page 79)	Same programme every day	–	–	
	All days are different	–	–	
	Work days/weekend	Choose days	–	
		Event schedule	–	
(⚙ 4.4.5 'Setting room data' on page 82)	Setpoint XX.X °C	–	–	
	Setpoint XX %rh	–	–	
	Setpoint XXX ppm	–	–	
Settings	(⚙ 4.3.2 'Selecting a language' on page 76)	–	–	
	(⚙ 4.3.3 'Setting the date' on page 76)	–	–	
	(⚙ 4.3.4 'Setting the time' on page 77)	–	–	
	(⚙ 4.4.3 'Setting an override timeout' on page 79)	–	–	
	(⚙ 4.3.5 'Showing or hiding the main menu' on page 77)	–	–	
	(⚙ 4.4.6 'Setting the volume flow rate for a room' on page 82)	–	–	
	(⚙ 4.4.2 'Activating a frost or window contact' on page 78)	–	–	
	(⚙ 4.4.7 'Setting the screen saver activation time' on page 83)	–	–	
	(⚙ 4.4.1 'Setting the configuration mode' on page 78)	–	–	
	(⚙ 4.4.8 'Setting PI values' on page 83)		PI-reg. P-Band	
			PI Reg I-time	VAV damper XX sec
			Cooling valve XXX sec	
			Heating valve XXX sec	
(⚙ 4.6.3 'Viewing system information' on page 86)		Room panel	–	
		ZoneModule	–	
(⚙ 4.6.4 'Help' on page 86)	–	–	–	

4.3 Setting up the X-AIR-CP-2T control panel

4.3.1 Password entry

Several 'Main Menu' functions are password protected. When you click on a password protected function on the 'Main Menu', the 'Please enter code' prompt (Fig. 74) displays. The default password is '1234'.

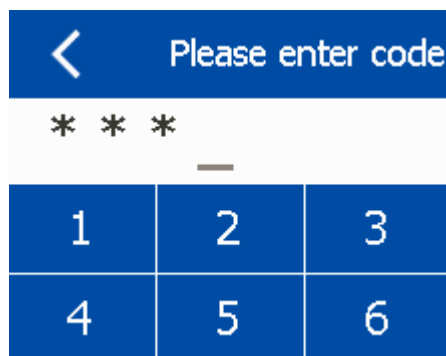

Fig. 74: Password entry

- ▶ When the 'Please enter code' prompt displays (Fig. 74), enter the 4-digit password.
- ⇒ The screen for the required function displays.

4.3.2 Selecting a language

The 'Language' screen (Fig. 75) allows you to select a language.

- German
- Danish
- English
- Spanish
- French
- Italian
- Dutch
- Norwegian
- Polish
- Russian
- Swedish
- Finnish

1. ▶ On the main menu, go to 'Settings → Language' .
2. ▶ Enter your password (↪ 4.3.1 'Password entry' on page 76).
 - ⇒ The first 'Language selection' screen (Fig. 75) displays.

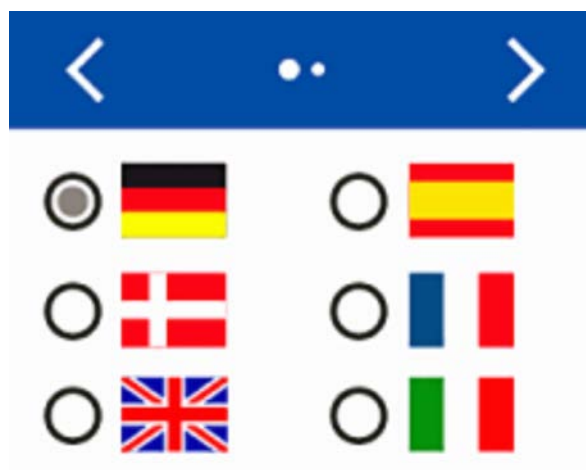

Fig. 75: Language selection screen 1

3. ▶ Select a language.
4. ▶ Note that there is a second screen with more languages (Fig. 76).



Fig. 76: Language selection screen 2

5. ▶ On 'Language' selection screen 2 (Fig. 76), select a language.
 - ⇒ The display language has been set.

4.3.3 Setting the date

The 'Date/format' screen (Fig. 77) allows you to set the current date and the date format. Available date formats are day/month/year and month/day/year.

1. ▶ On the main menu, go to 'Settings → Date' .
 - ⇒ The 'Date/format' screen (Fig. 77) displays.

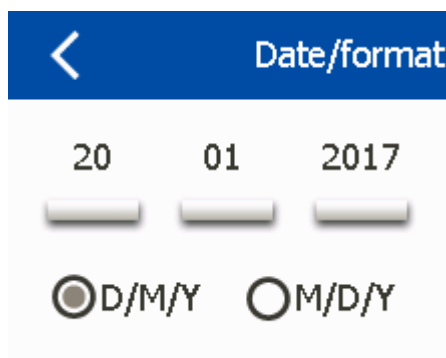

Fig. 77: Setting the date

2. ▶ Enter the current date (Fig. 77).
3. ▶ Select a date format.
 - ⇒ The current date has been set in the selected date format.

4.3.4 Setting the time

The 'Time/format' screen (Fig. 78) allows you to set the current time and select a time format. You can choose between 12-hour clock and 24-hour clock.

1. ▶ On the main menu, go to 'Settings → Time' .
 - ⇒ The 'Time/format' screen (Fig. 78) displays.

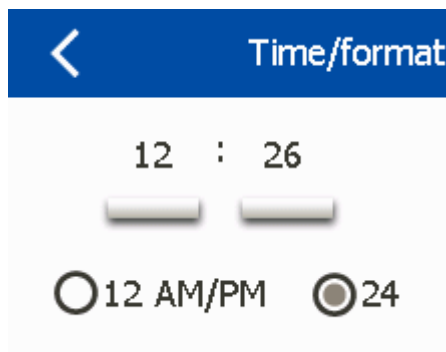

Fig. 78: Setting the time

2. ▶ Set the current time.
3. ▶ Select a time format.
 - ⇒ The current time has been set in the selected time format.

4.3.5 Showing or hiding the main menu

The 'Menu hide' screen (Fig. 79) allows you to choose whether the main menu button on the Start screen (§ 4.2 'Start screen functions' on page 74) should be shown or hidden. If you choose to hide the main menu button, the main menu cannot be accessed from the Start screen. No main menu functions will be available then.

1. ▶ On the main menu, go to 'Settings → Menu hide' .

2. ▶ Enter your password (§ 4.3.1 'Password entry' on page 76).
 - ⇒ The 'Menu hide' screen (Fig. 79) displays.

Hiding the main menu button

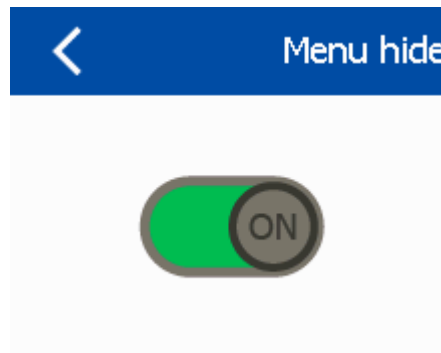

Fig. 79: Menu hide

3. ▶ Click on the green button (Fig. 79).
 - ⇒ The main menu button on the Start screen (§ 4.2 'Start screen functions' on page 74) is now hidden.

Showing the main menu button

4. ▶ On the Start screen (§ 4.2 'Start screen functions' on page 74), click five times in the top right corner, where the main menu button is hidden.
5. ▶ On the main menu, go to 'Settings → Menu hide' .
6. ▶ Enter your password (§ 4.3.1 'Password entry' on page 76).
 - ⇒ The 'Menu hide' screen (Fig. 80) displays.

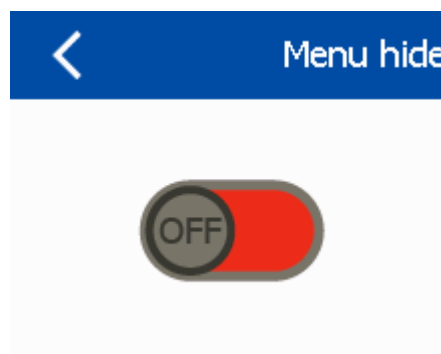

Fig. 80: Showing the menu

7. ▶ Click on the red button.
 - ⇒ The main menu button on the Start screen (§ 4.2 'Start screen functions' on page 74) is now visible and active.

4.4 Configuring a zone module

4.4.1 Setting the configuration mode

The 'Config mode' screen (Fig. 81) allows you to configure the sensors and actuators connected to a zone module and to have them automatically detected. If you have selected automatic mode, all actors and sensors connected to the zone module will be automatically detected and activated. This automatic configuration also allows you to deactivate individual sensors or actuators without while the system is in operation; no fault will be generated.

Once all actuators and sensors have been connected to the zone module and detected in automatic mode, you can change to manual mode. While manual mode is active, the connected actuators and sensors are monitored such that hardware problems and connection errors will be detected. There is no automatic detection of the zone module inputs and outputs in manual mode.

1. ▶ On the main menu, go to 'Settings' → 'Config mode'.
2. ▶ Enter your password (↪ 4.3.1 'Password entry' on page 76).
 - ⇒ The 'Config mode' screen (Fig. 81) displays.

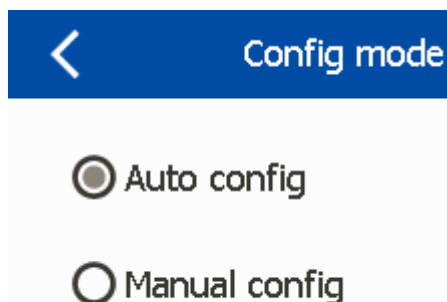

Fig. 81: Config mode

3. ▶ Select 'Auto config' to have the system automatically detect the connected actuators and sensors.
 - ⇒ The actuators and sensors have been detected.
4. ▶ Select 'Manual config'.
 - ⇒ Monitoring of the connected actuators and sensors is now active.

4.4.2 Activating a frost or window contact

The 'Frost/Window' screen (Fig. 82) allows you to activate or deactivate a frost protection sensor and a window contact on the zone module.

The digital 'Windows/Frost' input of the zone module allows you to connect a frost protection sensor (e.g. a capillary tube sensor with a digital output) or a window contact. If you have enabled 'frost protection' on the zone module, the zone master will deactivate the con-

nected slave devices if a critical temperature is reached. If you have enabled the window contact on the zone module, the zone master will deactivate the connected slave devices if someone opens the window that is being monitored.

1. ▶ On the main menu, go to 'Settings' → 'Frost/Window'.
2. ▶ Enter your password (↪ 4.3.1 'Password entry' on page 76).
 - ⇒ The 'Frost/Window' screen (Fig. 82) displays.

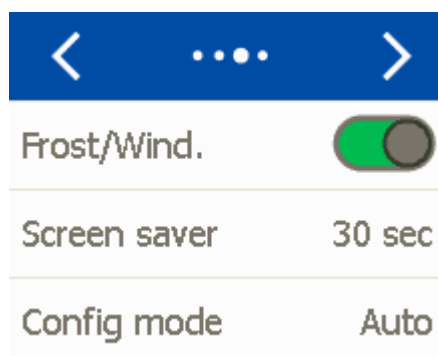

Fig. 82: Frost sensor / window contact

3. ▶ If the 'Frost/Window' function is not active, click on the Frost/Window button (Fig. 82).
 - ⇒ The colour changes from red to green. Frost protection or window contact is now active.

Activating frost protection



Fig. 83: Frost/Window

4. ▶ Select 'Frost protection'.
 - ⇒ Frost protection is now active. If the temperature falls below a set critical value, the zone module switches the connected volume flow controller and cooling valve off and opens the heating valve.

Activating a window contact

5. ▶ Select 'Window contact'.
 - ⇒ The window contact function is now active. If someone opens the window that is being monitored, the zone module sends the appropriate control input signals to the connected volume flow controller, heating valve and cooling valve.

Deactivating frost protection and window contact

6. ▶ If no frost protection sensor and no window contact have been connected to the zone module, go to the screen in Fig. 83 and click on the green button.
 - ⇒ The colour changes from green to red. Frost protection and window contact are no longer active.

4.4.3 Setting an override timeout

The 'Override timeout' screen (Fig. 84) allows you to set a timeout period from 10 minutes to 90 minutes, in 1-minute increments. The default (factory) override timeout is 60 minutes. Override control is enabled as soon as you activate 'ventilation override' (§ 4.5.1 'Setting the volume flow rate' on page 84) or 'temperature override' (§ 4.5.2 'Setting a temperature set-point value' on page 85). When the override timeout has elapsed, the system returns to the setpoints of the schedule (§ 4.4.4 'Setting up schedules' on page 79). During the override timeout period the schedule is not active. Override timeout settings are of higher priority than any schedule. If someone makes changes to the ventilation or temperature override settings before the timeout period has elapsed, the timeout period will be reset.

1. ▶ On the main menu, go to 'Settings' → 'Overr. timeout'.
 - ⇒ The 'Override timeout' screen (Fig. 84) displays.

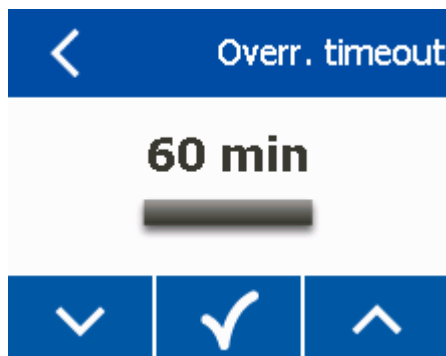

Fig. 84: Override timeout

2. ▶ Use the ▼ and ▲ buttons (Fig. 84) to set the override timeout.
3. ▶ Click on ✓ (Fig. 84).
 - ⇒ The override timeout has been set.

4.4.4 Setting up schedules

The 'Schedule' screen (§ 4.2 'Start screen functions' on page 74) allows you to set up different schedules:

- Identical schedule for all days ('Same programme for every day')
- Different schedule for every day ('All days are different')
- Different schedules for working days and weekends ('Work days/Weekend')

Every day is divided into four periods: morning, afternoon, evening and night. You can individually set the supply air flow rate, the room temperature and the start time for each period of a day. You can set the supply air flow rate to off, minimum, maximum or automatic, and you can set the temperature individually.

Schedules are active only if no ventilation or temperature override has been enabled on the 'Start' screen (§ 4.2 'Start screen functions' on page 74), i.e. if ventilation override has been set to automatic. Ventilation and temperature override control has priority over schedules.

1. ▶ On the main menu, select 'Schedule'.
 - ⇒ The 'Week schedule' screen (Fig. 85) displays.

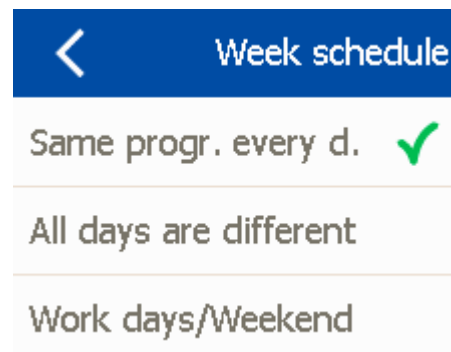

Fig. 85: Week schedule

2. ▶ Select a type of schedule (Fig. 85).

Setting a different schedule for each day

You can set the room temperature and volume flow rate for each day individually.

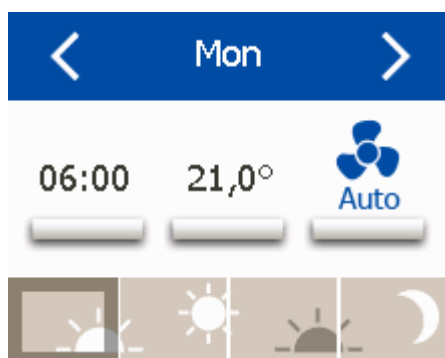

Fig. 86: Individual settings for each day

1. ▶ Use the screen in Fig. 86 to select a day of the week using the ◀ and ▶ buttons.
2. ▶ Click on the symbol for a time of the day (morning, afternoon, evening, night).
3. ▶ Click on the button for setting the start time for the time of day.

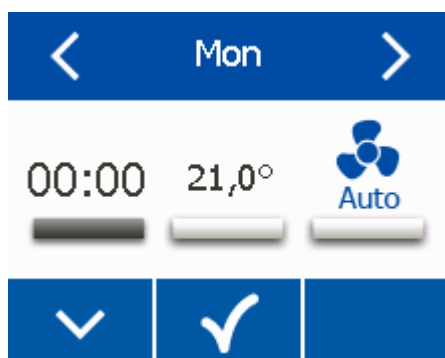

Fig. 87: Setting the time of day

4. ▶ On the screen in Fig. 87 set the start time for the selected time of the day using the ▼ and ▲ buttons; then confirm your entry by clicking ✓.
5. ▶ On the screen in Fig. 86 click on the button for the room temperature.

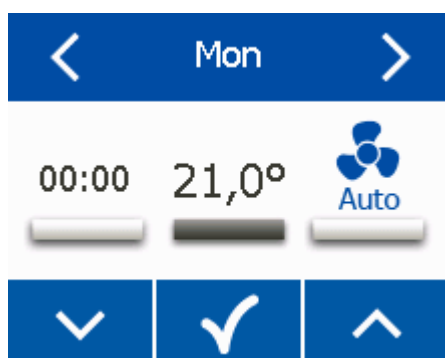

Fig. 88: Setting the room temperature

6. ▶ On the screen in Fig. 88 set the room temperature using the ▼ and ▲ buttons; then confirm your entry by clicking ✓.

7. ▶ On the screen in Fig. 86 click on the button for the supply air flow rate.

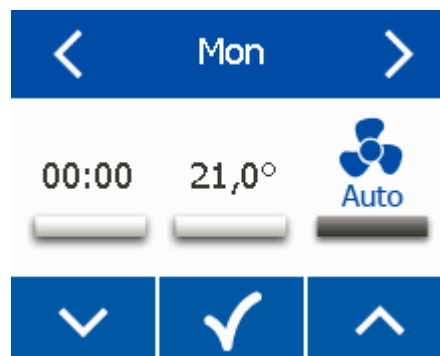

Fig. 89: Setting the supply air flow rate

8. ▶ On the screen in Fig. 89 set a mode for the supply air flow rate using the ▼ and ▲ buttons; then confirm your selection by clicking ✓.
9. ▶ On the screen in Fig. 86 select the next day of the week and repeat steps 2 to 8.
 - ⇒ The individual schedules for all days have been set.

Setting up an identical schedule for all days

The schedule you set up here will apply to all days.

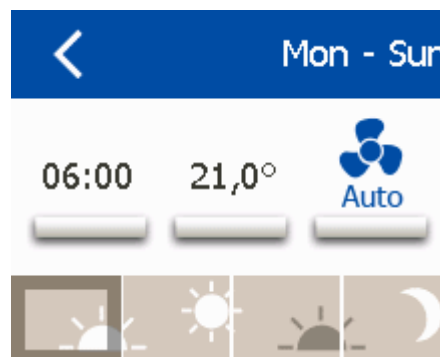

Fig. 90: Same programme every day

1. ▶ On the screen in Fig. 90 click on the symbol for a time of the day (morning, afternoon, evening, night).
2. ▶ Click on the button for setting the start time for the time of day.
3. ▶ Enter the start time for the selected time of day and confirm your entry.
4. ▶ Click on the button for setting the room temperature.
5. ▶ Enter the room temperature for the selected time of the day and confirm your entry.
6. ▶ Click on the button for setting the volume flow rate.

- 7. ▶ Select a mode for the supply air flow rate and confirm your selection.
 - ⇒ The schedule for the week has been set up.

Setting up different schedules for working days and weekends

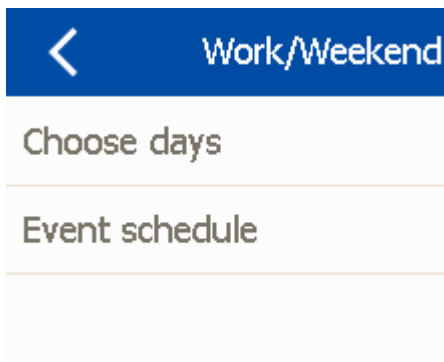

Fig. 91: Working days and weekend

- 1. ▶ On the screen in Fig. 91 click on 'Choose days'.
 - ⇒ The 'Work days' screen (Fig. 92) displays.

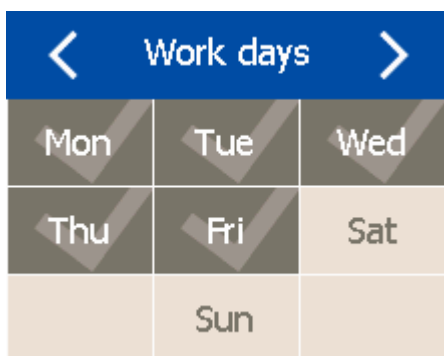

Fig. 92: Working days

- 2. ▶ Use the screen in Fig. 92 to select all working days of the week.
- 3. ▶ Go to the 'Weekend' screen (Fig. 93).

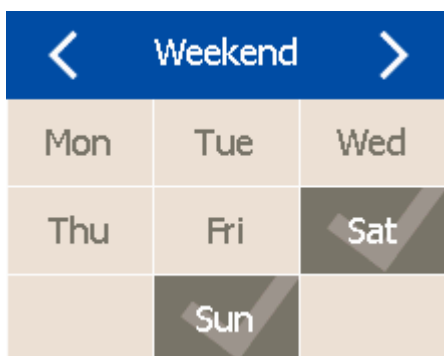

Fig. 93: Weekend

- 4. ▶ Use the 'Weekend' screen to select all days of the weekend.
- 5. ▶ Go to the 'Work/Weekend' screen (Fig. 91).
- 6. ▶ Click on 'Event schedule'.

- ⇒ The 'Work days' screen (Fig. 94) displays.

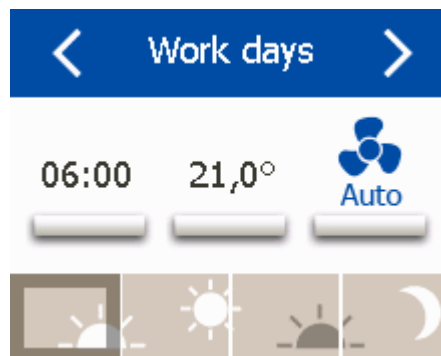

Fig. 94: Setting working days

- 7. ▶ Click on the symbol for a time of the day (morning, afternoon, evening, night).
- 8. ▶ Click on the button for setting the start time for the time of day.
- 9. ▶ Enter the start time for the selected time of day and confirm your entry.
- 10.▶ Click on the button for setting the room temperature.
- 11.▶ Enter the room temperature for the selected time of the day and confirm your entry.
- 12.▶ Click on the button for setting the volume flow rate.
- 13.▶ Select a mode for the supply air flow rate and confirm your selection.
 - ⇒ The schedule for working days has been set up.

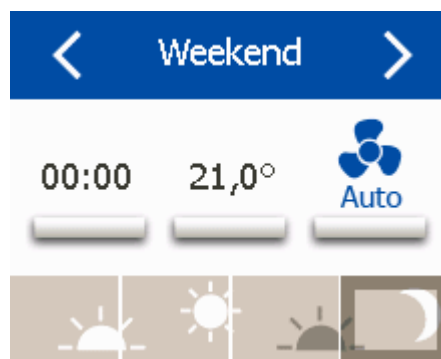

Fig. 95: Setting the weekend

- 14.▶ Go to the 'Weekend' screen (Fig. 95).
- 15.▶ Repeat steps 7 to 13 for the weekend.
 - ⇒ The schedules for working days and for the weekend have been set up.

4.4.5 Setting room data

The 'Room data' screen (Fig. 96) allows you to view the room data for a zone. This includes the actual values measured by the sensors in the zone, and the setpoint values for the zone module. Setpoints which you can set are displayed in white, actual values (as measured by sensors) are grey. You can view or set the following data.

Displayed values

- Room temperature actual value
- CO₂ or VOC actual value
- Humidity actual value
- Supply air flow rate actual value [m³/h]
- Supply air flow rate actual value [%]
- Supply air temperature
- Extract air flow rate actual value [m³/h]
- Extract air flow rate actual value [%]
- Extract air temperature
- Motion sensor contact (PIR)
- Heating [%]
- Cooling [%]
- Window contact

Adjustable values

- Room temperature setpoint value
- Room temperature setpoint offset value
- CO₂ or VOC setpoint value
- Humidity setpoint value

1. ▶ On the main menu, select 'Room data'.
⇒ The 'Room data' screen (Fig. 96) displays.

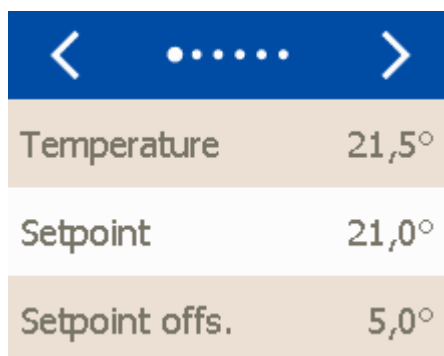

Fig. 96: Room data

2. ▶ The ◀ and ▶ buttons allow you to select the value you want to view or adjust.
3. ▶ To adjust a setpoint or to view an actual value, click on it.
4. ▶ Select a setpoint value using the ▲ and ▼ buttons; then confirm your selection by clicking ✓.
⇒ The setpoint has been set. If you have clicked on an actual value, it is being displayed.

4.4.6 Setting the volume flow rate for a room

The 'Air volume' screen (Fig. 97) allows you to set minimum and maximum volume flow rates to be used as 'Low' and 'High' values for the override function.

1. ▶ On the main menu, go to 'Settings → Air volume'.
2. ▶ Enter your password (§ 4.3.1 'Password entry' on page 76).
⇒ The 'Air volume' screen (Fig. 97) displays.

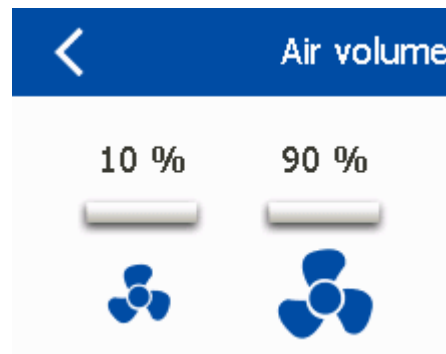

Fig. 97: Setting the air volume

3. ▶ Click on the left button.
⇒ The next screen (Fig. 98) displays, where you can set the 'Low' value for the volume flow rate override function.

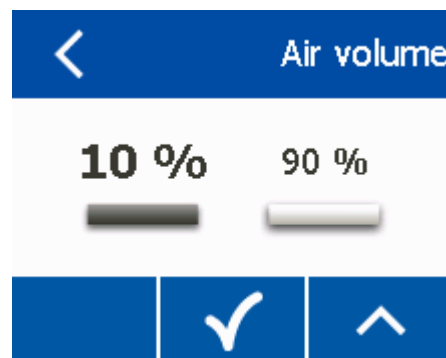

Fig. 98: Setting the low air volume

4. ▶ Set the percentage for the 'low air flow' setting in override mode using the ▲ and ▼ buttons; then confirm your setting by clicking ✓.
⇒ Your setting has been saved.
5. ▶ Click on the right button.
⇒ The next screen (Fig. 99) displays, where you can set the percentage for the 'High' air flow setting in override mode.

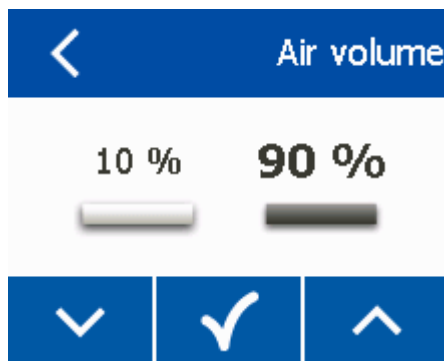

Fig. 99: Setting the low air volume

6. ▶ Set the percentage for the 'high air flow' setting in override mode using the ▲ and ▼ buttons; then confirm your setting by clicking ✓.
 - ⇒ Your setting has been saved.

4.4.7 Setting the screen saver activation time

The 'Screen saver' screen (Fig. 100) allows you to set the time after which the screen saver shall be activated. The screen saver displays when the screen has not been touched for the set number of seconds. You can set any time between 15 seconds and 60 seconds.

1. ▶ On the main menu, go to 'Settings → Screen saver' .
2. ▶ Enter your password (↪ 4.3.1 'Password entry' on page 76).
 - ⇒ The 'Screen saver' screen (Fig. 100) displays.

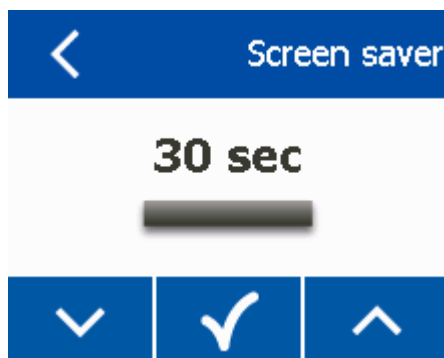

Fig. 100: Screen saver

3. ▶ Set a time using the ▲ and ▼ buttons; then confirm your setting by clicking ✓.
 - ⇒ The time has been saved.

4.4.8 Setting PI values

Setpoint values are controlled by a PI controller (called 'PI regulator' in the software). The 'PI regulator' screen (Fig. 101) allows you to set the P and I values for the PI controller. Once you change any P or I values, you cannot reset the controller to the factory set default values.



The PI control values are factory set, and you should not change them yourself. Otherwise PI control may become unstable. Only the TROX Technical Service or specifically trained experts should change the PI control values. Structural conditions (building) have to be considered.

1. ▶ On the main menu, go to 'Settings → PI regulator' .
2. ▶ Enter your password (↪ 4.3.1 'Password entry' on page 76).
 - ⇒ The 'PI regulator' screen (Fig. 101) displays.

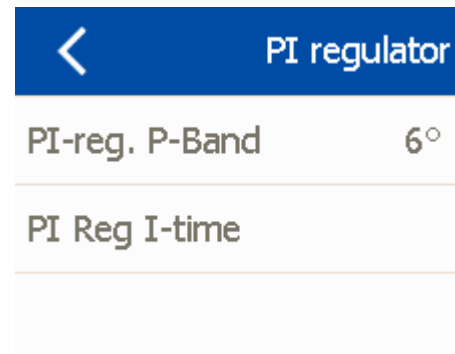

Fig. 101: PI controller

3. ▶ Click on 'PI-reg. P-Band' .
 - ⇒ The 'PI-reg. P-Band' screen (Fig. 102) displays.

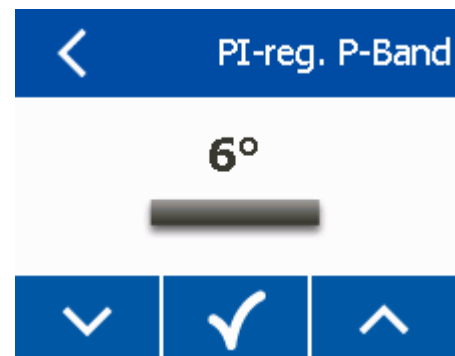

Fig. 102: PI-reg. P-Band

4. ▶ Set the P-Band value using the ▲ and ▼ buttons; then confirm your setting by clicking ✓.
 - ⇒ The P-Band value has been saved.

5. ▶ On the screen in Fig. 101 , click on 'PI Reg I-time'.
 - ⇒ The 'PI Reg I-time' screen (Fig. 103) displays.

PI Reg I-time	
VAV damper	500 sec
Cooling valve	800 sec
Heating valve	700 sec

Fig. 103: PI Reg I-time

6. ▶ On the screen in Fig. 103 , click on 'VAV damper'.



Fig. 104: VAV damper

7. ▶ Set a time using the ▲ and ▼ buttons; then confirm your entry by clicking ✓.
 - ⇒ The time has been saved.
8. ▶ On the screen in Fig. 103 , click on 'Cooling valve'.

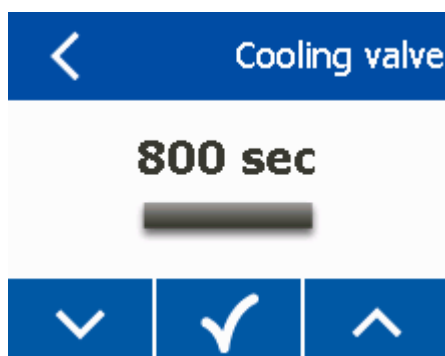

Fig. 105: Cooling valve

9. ▶ Set a time using the ▲ and ▼ buttons; then confirm your entry by clicking ✓.
 - ⇒ The time has been saved.
- 10.▶ On the screen in Fig. 103 , click on 'Heating valve'.

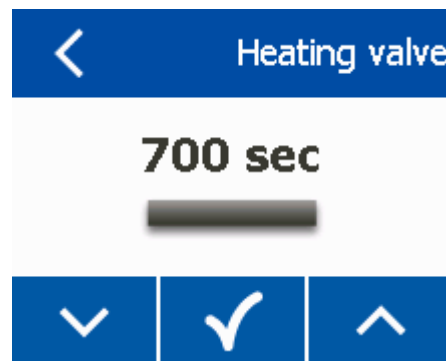

Fig. 106: Heating valve

- 11.▶ Set a time using the ▲ and ▼ buttons; then confirm your entry by clicking ✓.
 - ⇒ The time has been saved.

The PI values for the PI controller (called 'PI regulator' in the software) have been set.

4.5 Using the zone module

4.5.1 Setting the volume flow rate

The 'Start' screen (Fig. 107) allows you to set the volume flow rate override function. The volume flow rate is controlled by the supply air controllers (variable air volume).

You can choose between 'off', 'low', 'high' and 'Automatic'. If you choose 'off', 'low' or 'high', volume flow rate override is active for the time you have previously set (↪ 4.4.3 'Setting an override timeout' on page 79). If the set time has elapsed, the zone module resumes automatic control and also the current schedule.

If you choose 'off', all VAV supply air units remain closed. Variants 'low' and 'high' can be set separately, see ↪ 4.4.6 'Setting the volume flow rate for a room' on page 82 .

If volume flow rate override is active and the voltage supply to the control panel fails, however briefly, the volume flow rate override is reset and automatic mode resumes.



Fig. 107: Start screen

- ▶ On the Start screen (Fig. 107), select an override mode by using the ▲ and ▼ buttons.
 - ⇒ The mode you select remains active for the preset time (override timeout).
If the set time has elapsed, the zone module resumes automatic control and also the current schedule.

4.5.2 Setting a temperature setpoint value

The 'Start' screen (Fig. 108) allows you to override the temperature setpoint value. You can set the room temperature in increments of 0.5 °C. The temperature setpoint you set remains active for the preset time (override timeout). If the override timeout period has elapsed, the zone module resumes control with the previous setpoint and also the current schedule.

If temperature setpoint override is active and the voltage supply to the control panel fails briefly, the temperature setpoint override remains active.



Fig. 108: Start screen

- ▶ The 'Start' screen (Fig. 107) allows you to set a room temperature using the ▲ and ▼ buttons.
 - ⇒ The temperature setpoint override value remains active for the preset time (override timeout).
If the set time has elapsed, the zone module resumes control with the previous setpoint and also the current schedule.

4.6 Viewing system settings

4.6.1 Viewing room air temperatures

You can view the current room air temperature either on the 'Start' screen (Fig. 109) or on the 'Room data' screen (§ 4.4.5 'Setting room data' on page 82).

Room air temperature on the 'Start' screen

1. ▶ Go to the 'Start' screen.



Fig. 109: Start screen

2. ▶ The room air temperature is displayed.

Room air temperature on the 'Room data' screen

3. ▶ On the main menu, select 'Room data'.
 - ⇒ The 'Room data' screen (Fig. 110) displays.

< ... >	
Temperature	21,5°
Setpoint	21,0°
Setpoint offs.	5,0°

Fig. 110: Room data

4. ▶ The room air temperature is displayed.

4.6.2 Viewing the volume flow rate for a room

You can view the volume flow rate for a room on the 'Room data' screen (Fig. 111).

1. ▶ On the main menu, select 'Room data' .
⇒ The 'Room data' screen displays.
2. ▶ Use the < and > buttons to go to the screen in Fig. 111 .

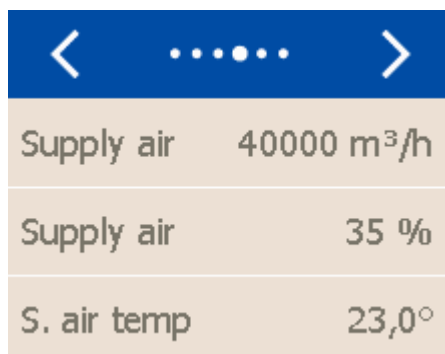

Fig. 111: Supply air

3. ▶ The volume flow rate of the room is displayed.

4.6.3 Viewing system information

The 'About' screen (Fig. 112) allows you to view the software version and the product numbers of the room control panel, zone module and zone master.

1. ▶ On the main menu, go to 'Settings → About' .
⇒ The 'About' screen (Fig. 112) displays.

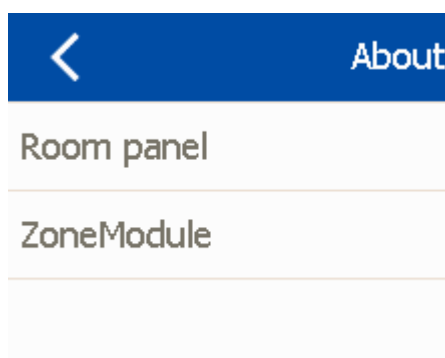

Fig. 112: About

2. ▶ Click on 'Room panel' or 'ZoneModule' .
⇒ The corresponding screen displays.

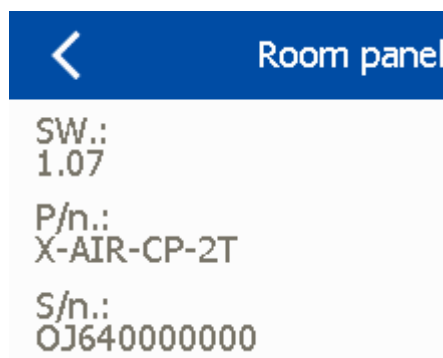

Fig. 113: Room panel

3. ▶ The software version and the product number and serial number of the room control panel are displayed.

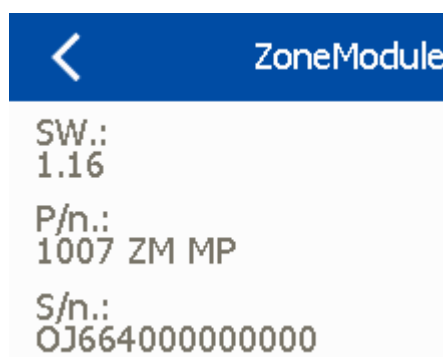

Fig. 114: ZoneModule

4. ▶ The software version and the product number and serial number of the zone module are displayed.

4.6.4 Help

The 'Help' screen (Fig. 115) displays a QR code that is linked to the TROX GmbH website. On the TROX website you will find the TROX Online Customer Centre with contact numbers.

1. ▶ On the main menu, select 'Help' .
⇒ The 'Help' screen (Fig. 115) displays.



Fig. 115: Help

2. ▶ Scan the QR code (Fig. 115) with your smartphone.
 - ⇒ The TROX GmbH website displays on your smartphone.
3. ▶ If you have any questions, contact the TROX Online Customer Centre.

4.6.5 Displaying alarms

For information on control panel alarm messages see chapter 9 'Troubleshooting' on page 96 .

5 Commissioning X-AIRCONTROL

5.1 Commissioning a stand-alone zone module

Personnel:

- Skilled qualified electrician

Once the components for a zone (zone module, control panel, sensors, actuators) have been installed and wired, you can start commissioning. For wiring, follow the instructions in 'General notes on wiring X-AIRCONTROL', available for download on our website www.troxtechnik.com.

To commission a zone module, proceed as follows:

1. ▶ Switch on the power supply to the zone module.
2. ▶ Check the configuration mode of the control panel or, if necessary, activate automatic configuration (↗ 4.4.1 'Setting the configuration mode' on page 78).
3. ▶ Address actuators and check whether the Vmin/ Vmax settings on the actuator are correct; adjust them, if necessary (↗ 8 'Setting up MP bus or Modbus actuators' on page 92).
4. ▶ Once the sensors and actuators have been successfully detected, set the configuration mode on the control panel to manual configuration (↗ 4.4.1 'Setting the configuration mode' on page 78).
5. ▶ Set up the zone module on the control panel (↗ 4.4 'Configuring a zone module' on page 78 /7).
6. ▶ Set up a schedule on the control panel (↗ 4.4.4 'Setting up schedules' on page 79).
7. ▶ Document the configuration values for the control panel and for the actuators.

5.2 Commissioning a zone module on a zone master

Personnel:

- Skilled qualified electrician
- Network administrator

Once the components for a zone (zone module, control panel, sensors, actuators) have been installed and wired, you can start commissioning. For wiring, follow the instructions in 'General notes on wiring X-AIRCONTROL', available for download on our website www.troxtechnik.com.

To commission a zone module on a zone master, proceed as follows:

1. ▶ Switch on the power supply for the zone modules of a zone master.
2. ▶ Switch on the power supply for the zone master.

3. ▶ Establish a network connection from a notebook or personal computer to the zone master (↗ 3.1 'Configuring the network access' on page 45).
⇒ You can now access all screens from the web-server for configuration.

Connecting zone modules to the zone master

Personnel:

- Skilled qualified electrician
- Network administrator

Before you make the fine adjustment of the VAV zone system, check whether the zone modules have been correctly installed in all the rooms.

The number of sections displayed depends on the number of X-AIRCONTROL zone masters installed.



There can be up to five zone masters. Each zone master represents a section.

1. ▶ Select a display language on the webserver (↗ 3.3 'Selecting a language' on page 47).
2. ▶ Log in to the webserver (↗ 3.4 'Logging in to the webserver' on page 48).
3. ▶ Activate the device detection mode for each section (↗ 3.8.1 'Activating the device detection mode' on page 51).
4. ▶ Check whether all sections are displayed on the 'Service' screen.
5. ▶ If necessary, check whether the zone master and the respective zone modules have been correctly installed.
6. ▶ Display the 'Auto Zone Setup' screen and check whether all zone modules are displayed.
7. ▶ If necessary, check that all zone modules have been correctly installed.
8. ▶ On the 'Auto Zone Setup' screen, check for each zone module whether all sensors and actuators are displayed; if they are displayed, it means they have been correctly connected.



Up to 25 zone modules can be connected to a zone master.

9. ▶ If necessary, check that the sensors and actuators have been correctly installed on the zone modules.
10. ▶ On the 'Auto Zone Setup' screen check the name of each zone; correct it, if necessary.
11. ▶ Click on 'Save'.

- 12.▶ Activate manual configuration of the actuators and sensors connected to the zone modules (↗ 3.8.2 'Configuring actuators and sensors' on page 53).
 - ⇒ If there is a configuration error, an alarm is issued on the webserver (↗ 9 'Troubleshooting' on page 96).
- 13.▶ Set the volume flow rates (↗ 3.8.3 'Setting the volume flow rate' on page 54).
- 14.▶ Set the supply branch (↗ 3.8.5 'Setting up a supply branch' on page 55).
- 15.▶ Set the extract branch (↗ 3.8.6 'Setting up an extract branch' on page 56).
 - ⇒ Installation of the zone modules on the zone master is now complete.

6 Integrating X-AIRCONTROL with a central BMS

Personnel:

- Network administrator
- Skilled qualified electrician
- HVAC technician

The TCP/IP-BMS interface allows you to integrate a zone master with the central BMS. The integral protocols 'Modbus/TCP' and 'BACnet IP' allow you to check, control and monitor an X-AIRCONTROL system in a central BMS from a central point.

Modbus/TCP

- The IP address for the Modbus/TCP protocol is the same as the IP address for the web server, i.e. 192.168.0.201.
- Communication:
 - TCP/IP
 - 10/100 Mbit Ethernet
 - RJ45 plugs (TCP/IP-BMS)
 - Port: 502

For more information on Modbus/TCP contact the TROX Online Customer Centre.

BACnet/IP

- The X-AIRCONTROL zone master is a BACnet Application Specific Controller (B-ASC). The BACnet server is factory enabled; you can adjust or deactivate it via the web server. To access the BACnet server, use the IP address of the web server (default: 192.168.0.201).
- Communication:
 - TCP/IP
 - 10/100 Mbit Ethernet
 - RJ45 plugs (TCP/IP-BMS)
 - Port: 47808 (can be changed)
- Object identifier
 - You can set the Object Identifier (Device-ID) to use the last five digits of the IP address of the X-AIRCONTROL zone master.
 - Example:
 - IP address = 172.21.0.95 ⇒ Object Identifier = 95
 - IP address = 155.37.0.216 ⇒ Object Identifier = 216
 - IP address = 155.37.35.123 ⇒ Object Identifier = 35123
 - IP address = 132.65.124.103 ⇒ Object Identifier = 24103
 - IP address = 172.20.211.47 ⇒ Object Identifier = 11047
 - IP address = 155.37.111.123 ⇒ Object Identifier = 11123
 - IP address = 168.25.111.1 ⇒ Object Identifier = 11001

Alternatively, you can set the Object Identifier (Device-ID) manually.

KNX-IP

The KNX-IP protocol is not available for the time being.

1. ▶ Log in to the web server (↪ 3.4 'Logging in to the webserver' on page 48).
2. ▶ On the Start screen (↪ 3.2 'Start screen functions' on page 46), click on the 'Tools' symbol.
 - ⇒ The Service screen displays.
3. ▶ On the 'Service' screen, go to BACnet configuration.
 - ⇒ The 'BACnet Setup' screen (Fig. 116) displays.

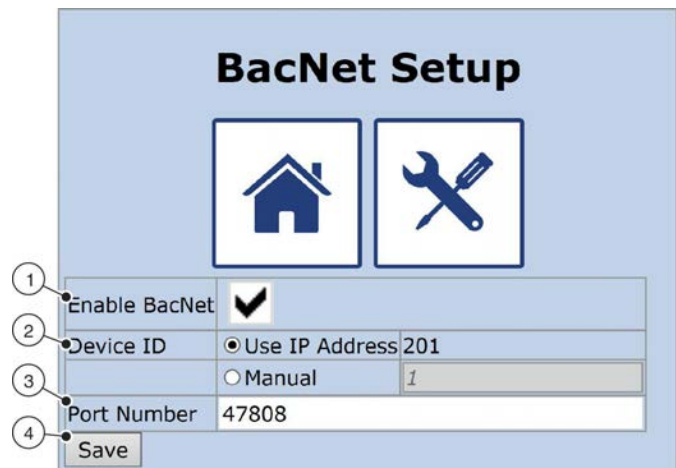

Fig. 116: BACnet setup

4. ▶ Enable BACnet (Fig. 116 /1).
5. ▶ Enable automatic or manual setting of the IP address (Fig. 116 /2).
6. ▶ Enter the port number (Fig. 116 /3).
7. ▶ Click on 'Save' (Fig. 116 /4).
 - ⇒ The BACnet protocol has been set up.

7 Connecting X-AIRCONTROL to an air handling unit (AHU)

Personnel:

- Network administrator
- Skilled qualified electrician
- HVAC technician

You can connect an AHU to analogue or digital inputs and outputs, or to the Modbus-AHU interface on an X-AIRCONTROL zone master. For information on available analogue and digital inputs and outputs see [2.2.1 'Zone master' on page 15](#).

-

The settings depend on whether the X-AIRCONTROL zone master controls the AHU through analogue or digital signals, or by means of the Modbus RTU protocol (RS485).

Type of AHU (Fig. 117 /1)

- None
 - The AHU is controlled with analogue or digital signals.
- TROX X-CUBE compact
 - The X-CUBE compact air handling unit is controlled by means of the Modbus RTU protocol (RS485).
- Customer-specific
 - The AHU (by others) is controlled by means of an adapted Modbus RTU protocol (RS485).

If you select 'None' or 'TROX X-CUBE compact', no further settings are required.

If more than one zone master has been connected, enter AHU type 'None' for zone sections 2 to 5 in a cascade ([2.1.3 'Control with 5 zone masters' on page 13](#)).

Setting up the Modbus-AHU interface for an air handling unit

1. ▶ Log in to the webserver ([3.4 'Logging in to the webserver' on page 48](#)).
2. ▶ On the Start screen ([3.2 'Start screen functions' on page 46](#)), click on the 'Tools' symbol.
 - ⇒ The Service screen displays.
3. ▶ On the 'Service' screen, open AHU Setup.
 - ⇒ The 'AHU Setup' screen (Fig. 117) displays.

Supported AHU Functions	Enable	Modbus Type	Address	Value	Scale	ReadingUnit
Set Supply Fan Control Loop	<input checked="" type="checkbox"/>	Holding Register	1	7	0	
Set Extract Fan Control Loop	<input checked="" type="checkbox"/>	Holding Register	1	7	0	
Set Temperature Control Loop	<input checked="" type="checkbox"/>	Holding Register	147	0	0	
Set Supply Fan Setpoint	<input checked="" type="checkbox"/>	Holding Register	241		0.01	0.0 %
Set Extract Fan Setpoint	<input checked="" type="checkbox"/>	Holding Register	242		0.01	0.0 %
Set Supply Air Temp. Setpoint	<input checked="" type="checkbox"/>	Holding Register	148		0.01	0.0 °C
Set PIR Input If PIR Active In A Zone	<input checked="" type="checkbox"/>	Coil Status	9	1		false
Read Summer Night Cooling Active	<input checked="" type="checkbox"/>	Input Status	10	1		false
Read Fire Active	<input checked="" type="checkbox"/>	Input Status	36	1		false
Read AHU In Stop	<input type="checkbox"/>	Input Register	0	0-99		true
Read AHU In Low Speed	<input type="checkbox"/>	Input Register	0	100-199		false
Read Outdoor Temperature	<input checked="" type="checkbox"/>	Input Register	23	0	0.01	0.0 °C
Read Supply Fan Alarm	<input checked="" type="checkbox"/>	Input Status	70	1		false
Read Extract Fan Alarm	<input checked="" type="checkbox"/>	Input Status	80	1		false
Read Combi-Coil Heat	<input type="checkbox"/>	Input Status	259	1		false
Read Combi-Coil Cool	<input type="checkbox"/>	Input Status	260	1		false

Fig. 117: AHU setup

4. ▶ Select the type of AHU (Fig. 117 /1).
5. ▶ If necessary, select the relevant AHU functions and enter the settings.
6. ▶ Click on 'Save' (Fig. 117 /4).
 - ⇒ The AHU communication protocol has been set up.

8 Setting up MP bus or Modbus actuators

8.1 Addressing MP bus or Modbus actuators

The following table shows the addresses of the X-AIR-CONTROL actuators. You can address and configure the actuators using the Belimo ZTH-EU control panel.

Address	Actuator
MP bus or Modbus	
1	Extract air volume flow controller
2	Supply air volume flow controller 1
3	Supply air volume flow controller 2
4	Heating valve
5	Cooling valve
6	Changeover mode
7	6-way valve

- ▶ For details on how to address and configure the actuators see the Belimo ZTH-EU operating manual.

8.2 LEDs on MP bus or Modbus actuators



Fig. 118: Actuator

- ▶ LEDs on an actuator (Fig. 118 /1+2).

LED	Function
LED green (‘Normal operation’ LED, Fig. 118 /1)	<ul style="list-style-type: none"> ■ Permanent light, green <ul style="list-style-type: none"> – Ready ■ Off <ul style="list-style-type: none"> – No power
LED yellow (Status LED, Fig. 118 /2)	<ul style="list-style-type: none"> ■ Permanent light, yellow <ul style="list-style-type: none"> – Adjustment or synchronisation in progress, restart ■ Off <ul style="list-style-type: none"> – Ready ■ Blinking (3 s interval) <ul style="list-style-type: none"> – Communication in progress

8.3 Configuring MP bus or Modbus actuators

If you connect the Belimo ZTH-EU control panel to a Belimo actuator, the control panel is switched on automatically and the data of the connected device are being displayed. The available setting options and functions are also being displayed.

There is an RJ12 socket on the control panel so that you can connect the control panel to an MP bus or Modbus. Use the configuration menu to select a display language and the units of measure you would like to have displayed. There is also a USB socket on the control panel so that you can connect a personal computer and use the Belimo PC software to check and adjust the communication settings and the operating parameters for the actuators.

The Belimo ZTH-EU control panel shows only options available for the device connected. These options come from the configuration table of the actuator. That table contains the types of parameter and the ranges that you can set, e.g. the minimum running time. Options that are not relevant are not displayed.



Fig. 119: ZTH-EU

Function of keys

Key	Functions
i	<ul style="list-style-type: none"> ■ Show additional information
ESC	<ul style="list-style-type: none"> ■ Cancel ■ Back ■ Discard changes
▼ and ▲	<ul style="list-style-type: none"> ■ Show next/previous value ■ Change status
OK	<ul style="list-style-type: none"> ■ Confirm entry ■ Show submenu

1. ▶ Connect the MP bus or Modbus cable to the RJ12 socket on the Belimo ZTH-EU control panel.
2. ▶ Connect the other end of the MP bus or Modbus cable to the RJ12 socket on the actuator.
3. ▶ Switch on the power supply.
 - ⇒ 'Startup' is being displayed.
 - The type name of the actuator is displayed, e.g. LMV-D3-MP.
4. ▶ Configure the actuator using the control panel.
5. ▶ For details see the control panel configuration menu (↪ 'Configuration menu' on page 94).

Configuration menu

Option or function	Adjustment	Device	Explanation
Delete cache	Yes/No	-	<ul style="list-style-type: none"> Data profiles of actuators for ventilation and air conditioning devices will be deleted from the local cache
Backlighting	Off after X seconds (0 to 255)/Permanently on	-	<ul style="list-style-type: none"> Period of time for which backlighting shall remain on
Show favourites	Off after 1 to 65635 s	Valves (Energie Valve)	<ul style="list-style-type: none"> Alternating display of the first three values after the set time has elapsed
OEM number	0 to 65535	VAV	-
Advanced Mode	Yes/No	VAV Fire protection Modbus	Enabling of functions <ul style="list-style-type: none"> VAV: direction of rotation VAV: Reset Vmin/Vmax (retrieve factory settings) BF Top: Adaptation Modbus: Basis address
Expert Mode	Yes/No	VAV Valves	Enabling of functions <ul style="list-style-type: none"> VAV: Change mode VAV: V'mid parameter VAV: Compensation for height
PICCV function	Yes/No	Valves	Belimo US <ul style="list-style-type: none"> Enable PICCV wizard function
Measure supply voltage	Value V AC	-	-
Pressure unit	Pa/in WC	VAV	-
Unit of measure for volume flow rate / water	m ³ /h l/min gpm	Valves	-
Unit of measure for volume flow rate / air	m ³ /h l/s cfm	VAV	-
Close configuration screen	ESC	-	-

Setting the address of an MP bus actuator (example)

MP address With MP-capable actuators, the MP address (PP, MP1-MP8) can be set.

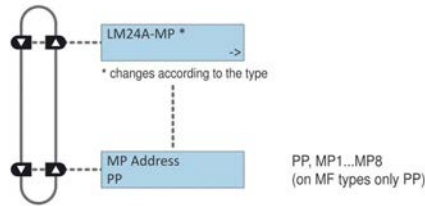

Fig. 120: Setting the address of an MP bus actuator

Setting the address of a Modbus actuator (example)

Modbus actuators Modbus-specific communication settings of an actuator with integrated Modbus interface (...-MOD).

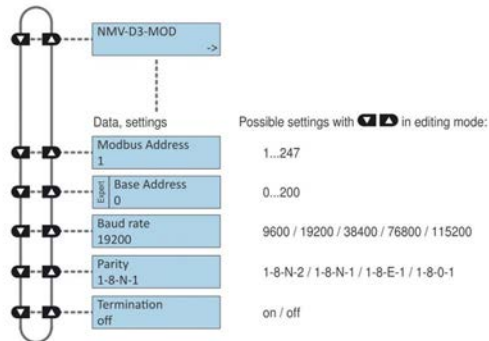

Fig. 121: Setting the address of a Modbus actuator

Setting Vmin and Vmax for an MP bus or Modbus actuator

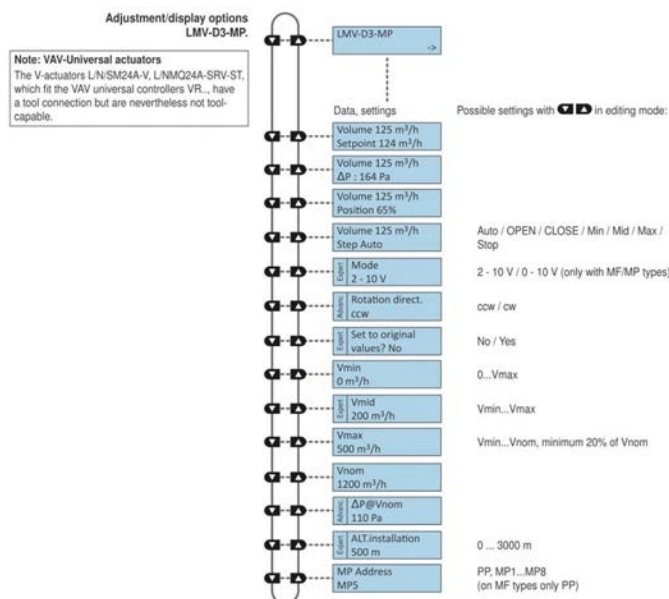

Fig. 122: Setting Vmin/Vmax

9 Troubleshooting

This chapter describes causes for errors as well as remedial action.

Alarms are displayed on the control panel (↗ 9.2 'Alarms displayed on the control panel' on page 96) or on the webserver (↗ 9.3 'Alarms displayed on the webserver' on page 100). Alarms are displayed as text messages, which you can acknowledge (reset the alarm).

If an error occurs repeatedly and if you cannot solve it by following the troubleshooting instructions, contact the Technical Service (↗ 'TROX Technical Service' on page 3).

9.1 Safe troubleshooting

Incorrect troubleshooting

WARNING!

Risk of injury from incorrect troubleshooting!

Incorrect troubleshooting can cause serious injuries and considerable damage to property.

- In case of any error or fault on the ventilation unit, first pull the mains plug.
- Faults that cannot be rectified according to the instructions in the Troubleshooting section have to be rectified by the TROX Technical Service.
- Do not open the casing cover while the ventilation unit is in operation.

Electric current

DANGER!

Danger of death due to electric current!

Danger of electric shock! Do not touch any live components! Damaged insulation or damaged parts are a life threatening hazard.

- Only skilled qualified electricians must work on the electrical systems.
- If the insulation is damaged, disconnect the power supply immediately and have the insulation repaired.
- Before you start maintenance or cleaning, pull the mains plug.
- Ensure that live parts do not come into contact with moisture. Moisture can cause a short circuit.

Rotating parts

WARNING!

Risk of injury from rotating parts!

Rotating parts in the fan can cause serious injuries.

- Before you start maintenance or cleaning, pull the mains plug.
- Do not reach into the moving fan.
- The fan does not stop immediately! Check that no parts are moving once you have opened the casing cover.
- Do not open the casing cover while the fan is in operation.

9.2 Alarms displayed on the control panel

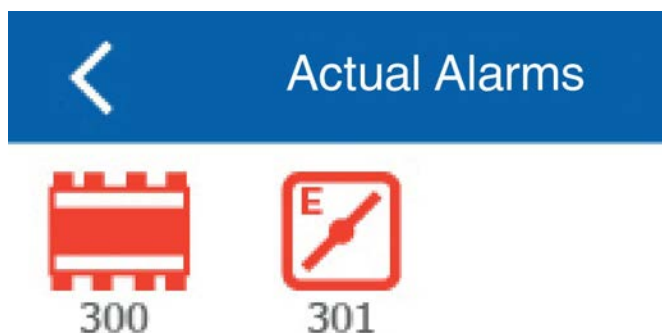

Fig. 123: Alarm messages

Alarms are shown on the Start screen of the control panel (Fig. 123 /1). There are two types of alarms: A and B.

System errors cause an A alarm, which is then displayed with a red bell symbol. The zone master is automatically switched off as a consequence.

Warnings cause a B alarm, which is then displayed with a yellow bell symbol. Warnings impair the function of X-AIRCONTROL, but the system will continue to run. During normal, fault-free operation, no alarm is being displayed.

Once a fault has been remedied, you can reset the alarm function on the webserver (↗ 9.3 'Alarms displayed on the webserver' on page 100).

Displaying alarms

Personnel:

- Network administrator
- Skilled qualified electrician

1. ▶ Go to the 'Start' screen of the control panel and click on the bell symbol.
 - ⇒ The 'Actual Alarms' screen (Fig. 123) displays.

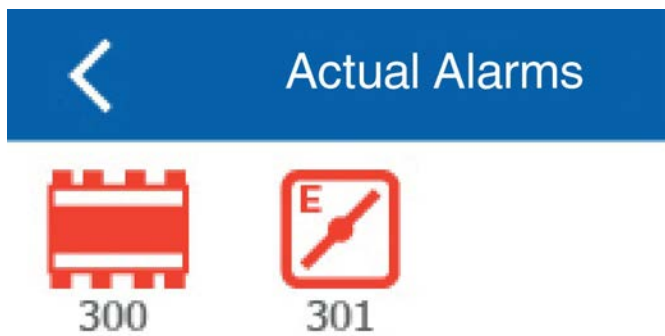

















Fig. 124: Current alarms (called 'actual alarms' in the software)

2. ▶ Note the alarm number on the screen in Fig. 123 , then go to the alarm table (↗ 'List of B alarms' on page 98) to find out more about the error.

List of B alarms

Alarm number	Alarm symbol	Cause	Remedial action
300	 300	X-AIRCONTROL zone module not connected	Check that both the X-AIRCONTROL zone module and the X-AIR-CP-2T control panel are supplied with power; reconnect, if necessary.
301	 301	Extract air volume flow controller – connection error	Check the connection between the X-AIRCONTROL zone module and the extract air volume flow controller (Extract VAV); reconnect, if necessary. Set the address of the volume flow controller to 1.
302	 302	Supply air volume flow controller 1 – connection error	Check the connection between the X-AIRCONTROL zone module and the supply air volume flow controller 1 (Supply VAV); reconnect, if necessary. Set the address of the volume flow controller to 2.
303	 303	Supply air volume flow controller 2 – connection error	Check the connection between the X-AIRCONTROL zone module and the supply air volume flow controller 2 (Supply VAV); reconnect, if necessary. Set the address of the volume flow controller to 3.
304	 304	Cooling valve actuator – connection error	Check the connection between the X-AIRCONTROL zone module and the cooling valve actuator; reconnect, if necessary. Set the address of the cooling valve actuator to 5.
305	 305	Heating valve actuator – connection error	Check the connection between the X-AIRCONTROL zone module and the heating valve actuator; reconnect, if necessary. Set the address of the cooling valve actuator to 5.
306	–	Heating/cooling valve actuator – connection error	Check the connection between the X-AIRCONTROL zone module and the heating/cooling valve actuator; reconnect, if necessary. Set the address of the cooling valve actuator to 6.
307	 307	Window contact or frost protection sensor – connection error	Check the connection between the window contact or frost protection sensor and the digital input or KNX router; reconnect, if necessary.

Alarm number	Alarm symbol	Cause	Remedial action
308	 	Motion detector (PIR) – connection error	Check the connection between the motion detector and the digital input or KNX router; reconnect, if necessary.
309		External room temperature sensor – connection error	<p>Check the room temperature sensor and the signal to 'Room C' or the Modbus sensor connection of the X-AIRCONTROL zone module; reconnect, if necessary.</p> <p>If the room temperature sensor is defective, replace it.</p>
310		Supply air temperature sensor – connection error	<p>Check the supply air temperature sensor and the signal to 'Room C' or the Modbus sensor connection of the X-AIRCONTROL zone module; reconnect, if necessary.</p> <p>If the supply air temperature sensor is defective, replace it.</p>
311		Setpoint offset sensor – connection error	<p>Check the room potentiometer and the signal to terminals 5, 6 and 7 of the X-AIRCONTROL zone module; reconnect, if necessary.</p> <p>If the room potentiometer is defective, replace it.</p>
312	 	CO ₂ /VOC sensor – connection error	<p>Check the CO₂/VOC sensor and the signal to the CO₂/VOC sensor or the Modbus sensor connection of the X-AIRCONTROL zone module; reconnect, if necessary.</p> <p>If the CO₂/VOC sensor is defective, replace it.</p>
313		Humidity sensor – connection error	<p>Check the humidity sensor and the signal to the humidity sensor or the Modbus sensor connection of the X-AIRCONTROL zone module; reconnect, if necessary.</p> <p>If the humidity sensor is defective, replace it.</p>
314	–	Short circuit on the room temperature sensor	<p>Check the room temperature sensor and the connection to 'Room C' of the X-AIRCONTROL zone module; reconnect, if necessary.</p> <p>If the room temperature sensor is defective, replace it.</p>
315	–	Short circuit on the supply air temperature sensor	<p>Check the room temperature sensor and the connection to 'Room C' of the X-AIRCONTROL zone module; reconnect, if necessary.</p> <p>If the room temperature sensor is defective, replace it.</p>

Alarm number	Alarm symbol	Cause	Remedial action
316	–	Extract air volume flow controller – mechanical defect	Check the extract air volume flow controller and actuator. If the volume flow controller is defective, replace it.
317	–	Supply air volume flow controller 1 – mechanical defect	Check the supply air volume flow controller 1 and actuator. If the volume flow controller is defective, replace it.
318	–	Supply air volume flow controller 2 – mechanical defect	Check the supply air volume flow controller 2 and actuator. If the volume flow controller is defective, replace it.
319	–	Cooling the valve actuator – mechanical defect	Check cooling valve and actuator. If the cooling valve or the actuator is defective, replace it.
320	–	Heating valve actuator – mechanical defect	Check the heating valve and actuator. If the heating valve or the actuator is defective, replace it.
321	–	Heating/cooling valve actuator – mechanical defect	Check the heating/cooling valve and actuator. If the heating/cooling valve or the actuator is defective, replace it.
322	–	X-AIRCONTROL zone module – hardware error	Replace the X-AIRCONTROL zone module.

9.3 Alarms displayed on the webserver

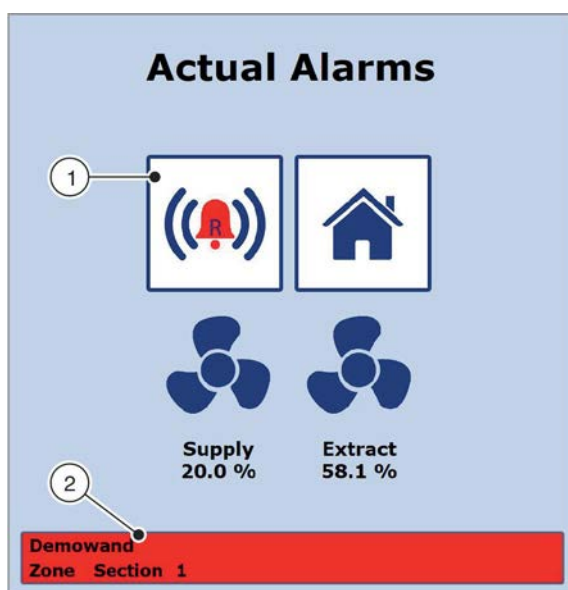

Fig. 125: Current alarms on the webserver

Alarms are shown on the Start screen of the webserver (Fig. 125 /1+2). There are two types of alarms: A and B.

System errors cause an A alarm, which is then displayed with a red bell symbol (Fig. 125 /1). The zone master is automatically switched off as a consequence.

Warnings cause a B alarm, which is then displayed with a yellow bell symbol. Warnings impair the function of X-AIRCONTROL, but the system will continue to run. The zone master which has caused the error is displayed in the red field (Fig. 125 /2).

During normal, fault-free operation, the bell symbol is green.

Once a fault has been remedied, you can reset the alarm function on the webserver (⇨ 'Resetting alarms' on page 103).

Displaying alarms

Personnel:

- Network administrator
- Skilled qualified electrician

1. ▶ Go to the 'Start' screen of the webserver and click on the bell symbol (Fig. 125 /1).
 - ⇨ The 'Actual Alarms' screen (Fig. 125) displays.

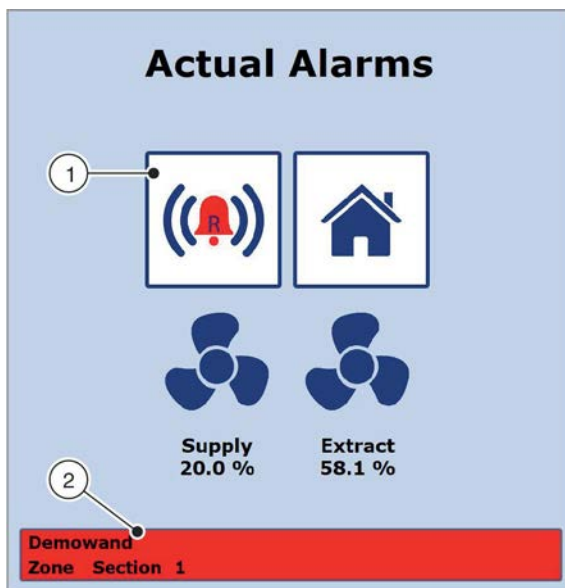

Fig. 126: Current alarms on the webserver

2. ▶ Click on the red field (Fig. 125 /2).
⇒ The alarm message is displayed.
3. ▶ Note the alarm number on the screen, then go to the alarm table (↵ 'List of zone master alarms' on page 102) to find out more about the error.

List of zone master alarms

Alarm number	Type of alarm	Cause	Remedial action
1	A	High cooling fluid temperature	Check cooling fluid, temperature sensor and alarm threshold. If the temperature sensor is defective, replace it.
2	A	Supply air fan	Check supply air fan, signal on zone master DI1 and Modbus connection to the AHU. Re-establish the connection, if necessary.
3	A	Extract air fan	Check extract air fan, signal to the zone master DI2 and Modbus connection to the AHU. Re-establish the connection, if necessary.
100	B	Outdoor air temperature sensor – error	Check outdoor air temperature sensor and signal to the zone master T2. Re-establish the connection, if necessary.
101	B	Cooling fluid temperature sensor – error	Check cooling fluid temperature sensor and signal to the zone master T1. If the cooling fluid temperature sensor is defective, replace it.
102	B	AHU has been switched off	Switch on the AHU and ensure that there is a Modbus connection to the AHU. Re-establish the connection, if necessary.
103	B	AHU configuration has failed	Check if the Modbus connection between the zone master and the AHU has been established. If the cooling fluid temperature sensor is defective, replace it. Check whether the register setting corresponds to the AHU Modbus protocol; correct it, if necessary.
104	B	Zone master, lower level connection has been interrupted	Check the Modbus connection between 'Zone Master In' of the zone master and 'Zone Master Out' of the zone master of the next lower level. Re-establish the connection, if necessary.
105	B	Zone master, higher level connection has been interrupted	Check the Modbus connection between 'Zone Master Out' of the zone master and 'Zone Master In' of the zone master of the next higher level. Re-establish the connection, if necessary.
106	B	Connection to KNX router has failed	Check whether the KNX router has been switched on and the TCP/IP plug has been connected. Check the IP address of the zone master; correct it, if necessary.

Alarm number	Type of alarm	Cause	Remedial action
107	B	Common extract air controller configuration – error	Check the common extract air controller configuration and correct it, if necessary.
108	B	Supply air pressure – error	Check the Modbus connection between supply air and extract air pressure transducers. Ensure that the rotary switch is set to position 2. Re-establish the connection, if necessary.
109	B	Extract air pressure sensor – error	Check the Modbus connection between 'Modbus Out 2' on the zone master and the extract air pressure transducer. Ensure that the rotary switch is set to position 1. Re-establish the connection, if necessary.
110	B	Supply branch, configuration of VAV terminal units	Check the configuration of VAV terminal units in the branch; correct it, if necessary.
111	B	Extract branch, configuration of VAV terminal units, error	Check the configuration of VAV terminal units in the branch; correct it, if necessary.
112	B	Short circuit on the outdoor air temperature sensor	Check outdoor sensor and connection to the zone master, terminals 13 and 14; correct, if necessary.
113	B	Short circuit on the cooling fluid temperature sensor	Check cooling fluid temperature sensor and signal to the zone master, terminals 12 and 13; correct, if necessary.

Resetting alarms

- ▶ If you have corrected all errors, click on the button in Fig. 125 /1.
 - ⇒ The alarms have been reset.

10 Wiring documents

10.1 Zone master

Connection of zone master

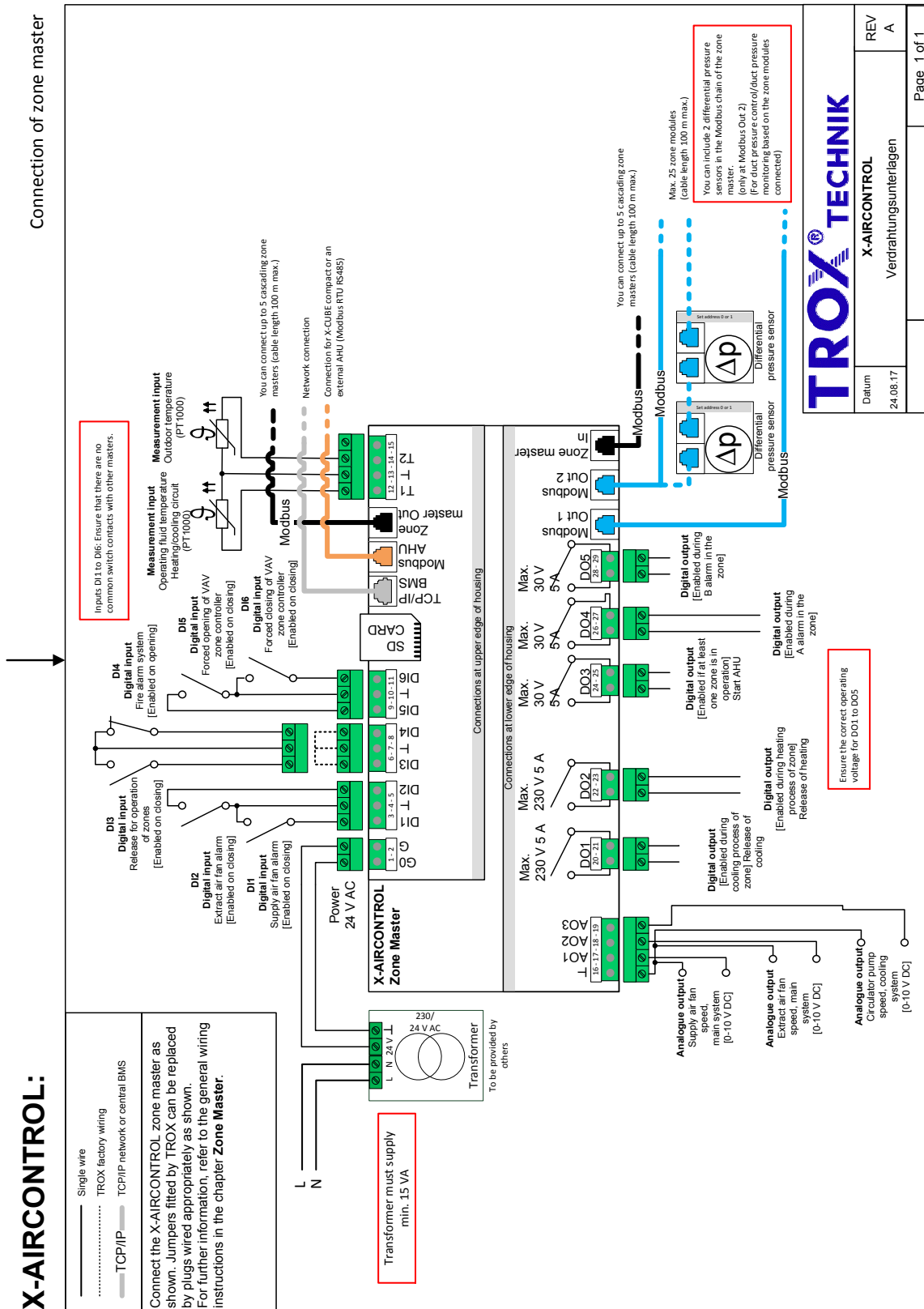

Fig. 127

10.2 Zone module X-AIR-ZMO-MP

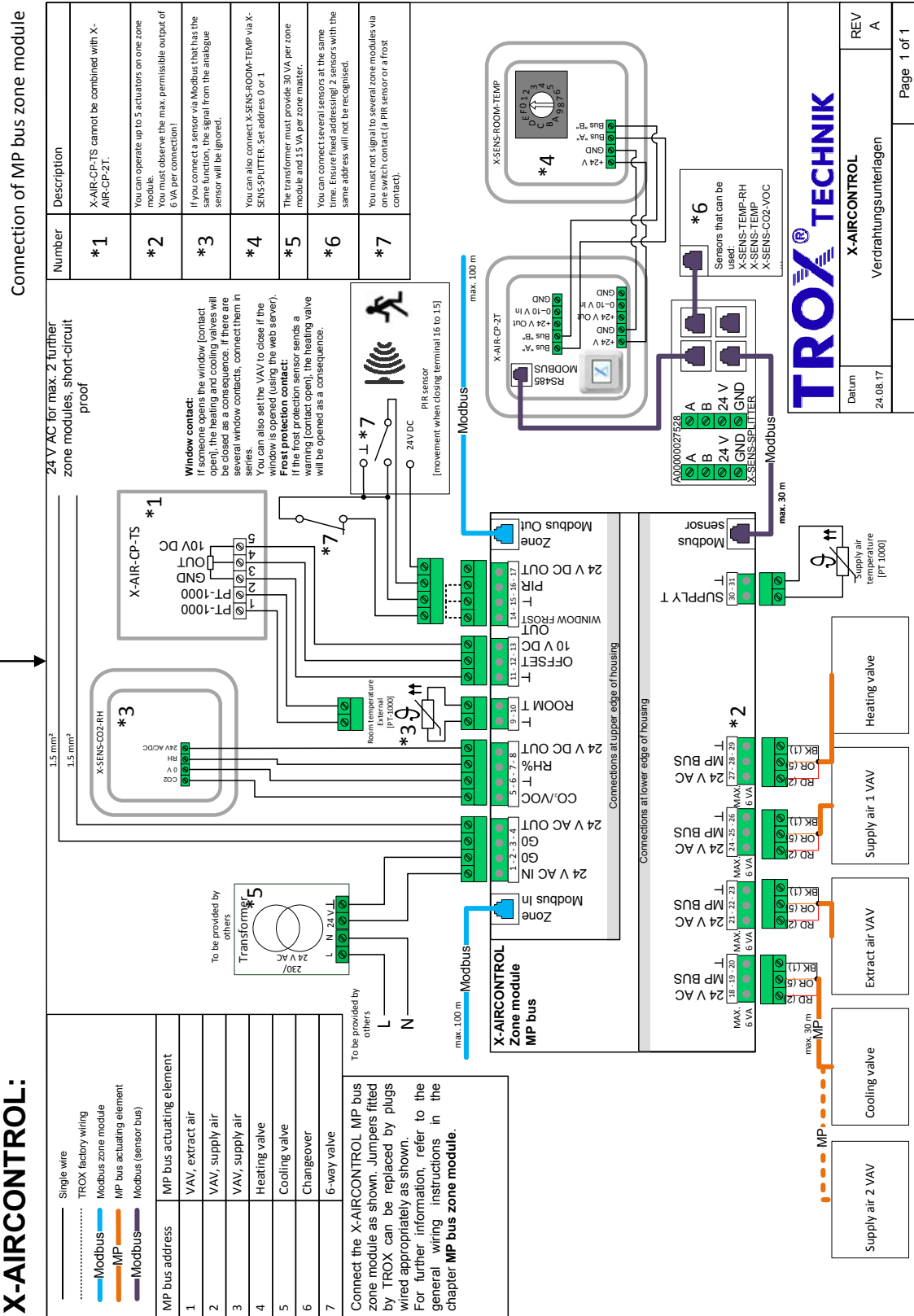

Fig. 128

10.3 Zone module X-AIR-ZMO-MOD

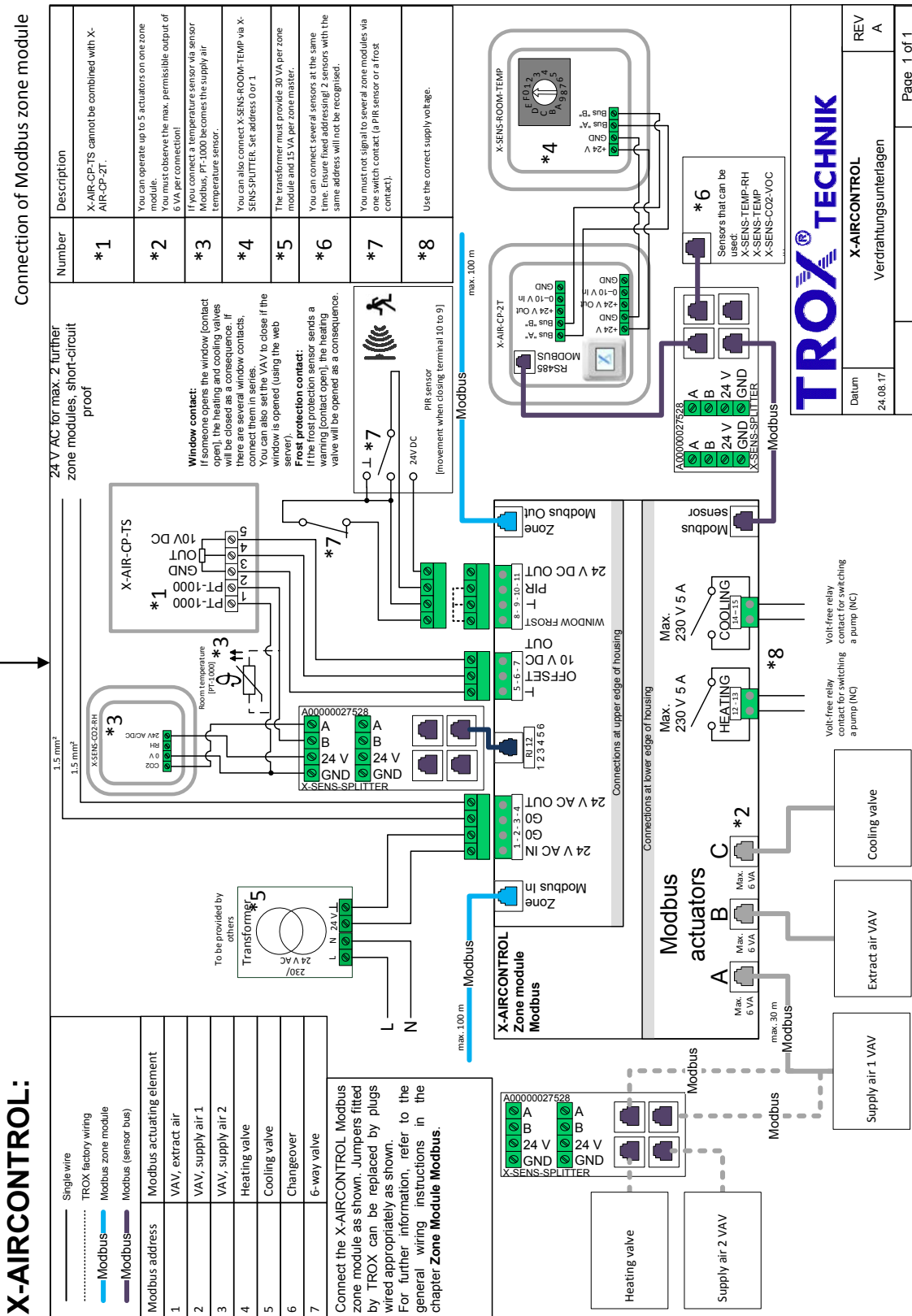

Fig. 129

X-AIRCONTROL
Verdrahtungsunterlagen

Datum: 24.08.17
REV: A

Page 1 of 1

10.4 Zone module X-AIR-ZMO-ANA

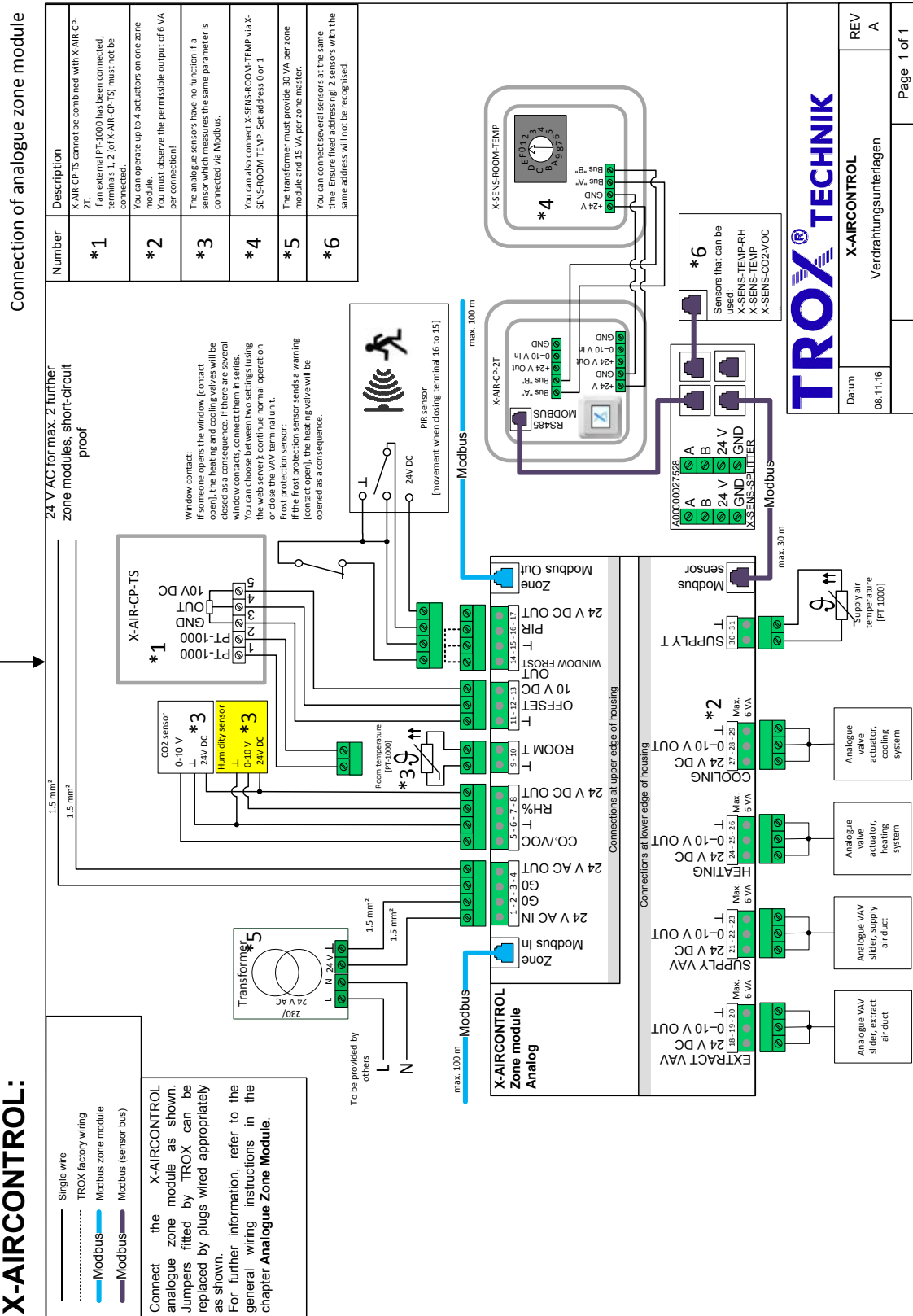

Fig. 130

11 Index

A

Analogue outputs..... 18 , 23 , 26 , 30

C

Cause..... 96

Configuring the network access..... 45

Connections..... 32 , 33 , 38

Copyright..... 3

Correct use..... 6

D

Defects liability..... 3

Digital inputs..... 18 , 23 , 26 , 30

Digital outputs..... 18 , 23 , 26 , 30

Dimensions and weight..... 31

E

Error description..... 96

H

Hotline..... 3

I

Incorrect use..... 6

L

Limitation of liability..... 3

List of errors..... 96

Logging in to the webserver..... 48

M

Modbus connection..... 23 , 26 , 30 , 34 , 35 , 36

N

Network connections..... 17

O

Other applicable documentation..... 3

P

Password entry..... 76

Passwords..... 8

Personal protective equipment..... 8

Personnel..... 7

Protective equipment..... 8

Q

Qualification..... 7

R

Remedy..... 96

Room air temperature

 Setting..... 85

 Viewing..... 85

Room control panel

 Alarm messages..... 87 , 96

 Ambient conditions..... 31 , 33

 Connections..... 31 , 33

 Dimensions..... 31 , 33

 Electrical data..... 31 , 33

 Password..... 8

 Product number..... 86

 Serial number..... 86

 Setting..... 59 , 74

 Setting up the touch panel..... 76

 Software version..... 86

 Start screen..... 74

 Switching on..... 74

 Technical data..... 31 , 33

 X-AIR-CP-2T..... 31

 X-AIR-CP-TS..... 33

S

Safe troubleshooting..... 96

Safety..... 6

Selecting a language..... 47 , 76

Sensor

 Ambient conditions..... 34

 Dimensions and weight..... 34

 Electrical data..... 34

 Network..... 34

 Technical data..... 34

Sensor inputs..... 18 , 23 , 26 , 30

Service..... 3

Setting system components..... 45 , 74

Setting the date..... 49 , 76

Setting the time..... 49 , 77

Setting zone values..... 59

Start screen functions..... 46 , 74

Symbols..... 6

System components..... 15

System description..... 10

System owner..... 7

System owner's obligations..... 7

System settings

 Viewing..... 85

System variants..... 10

T

Technical data..... 31

Technical Service..... 3

Touch panel

 Password..... 76

 Setting..... 76

U

Usage..... 6

Use..... 6

V

Volume flow rate

Checking.....	54
Setting.....	54 , 82
Viewing.....	86

W

Warranty claims.....	3
Web server.....	45

Z

Zone master

Alarm messages.....	96 , 100
Ambient conditions.....	15
Configuring.....	65
Connections.....	15
Dimensions and weight.....	15
Display elements.....	20

Power supply.....	15
Technical data.....	15
Zone module.....	19
Alarm messages.....	96
Ambient conditions.....	19
Commissioning.....	88
Configuring.....	51 , 78
Connections.....	19
Dimensions and weight.....	19
Display elements.....	20
Find.....	50
Power supply.....	19
Stand-alone.....	88
Technical data.....	19
Using.....	84

TROX[®] TECHNİK

The art of handling air

TROX GmbH
Heinrich-Trox-Platz
47504 Neukirchen-Vluyn, Ger-
many

Germany
+49 2845 202-0
+49 2845 202-265
E-mail: trox@trox.de
www.trox.de

© TROX GmbH 2017